

BELGARD
PAVES THE WAY™

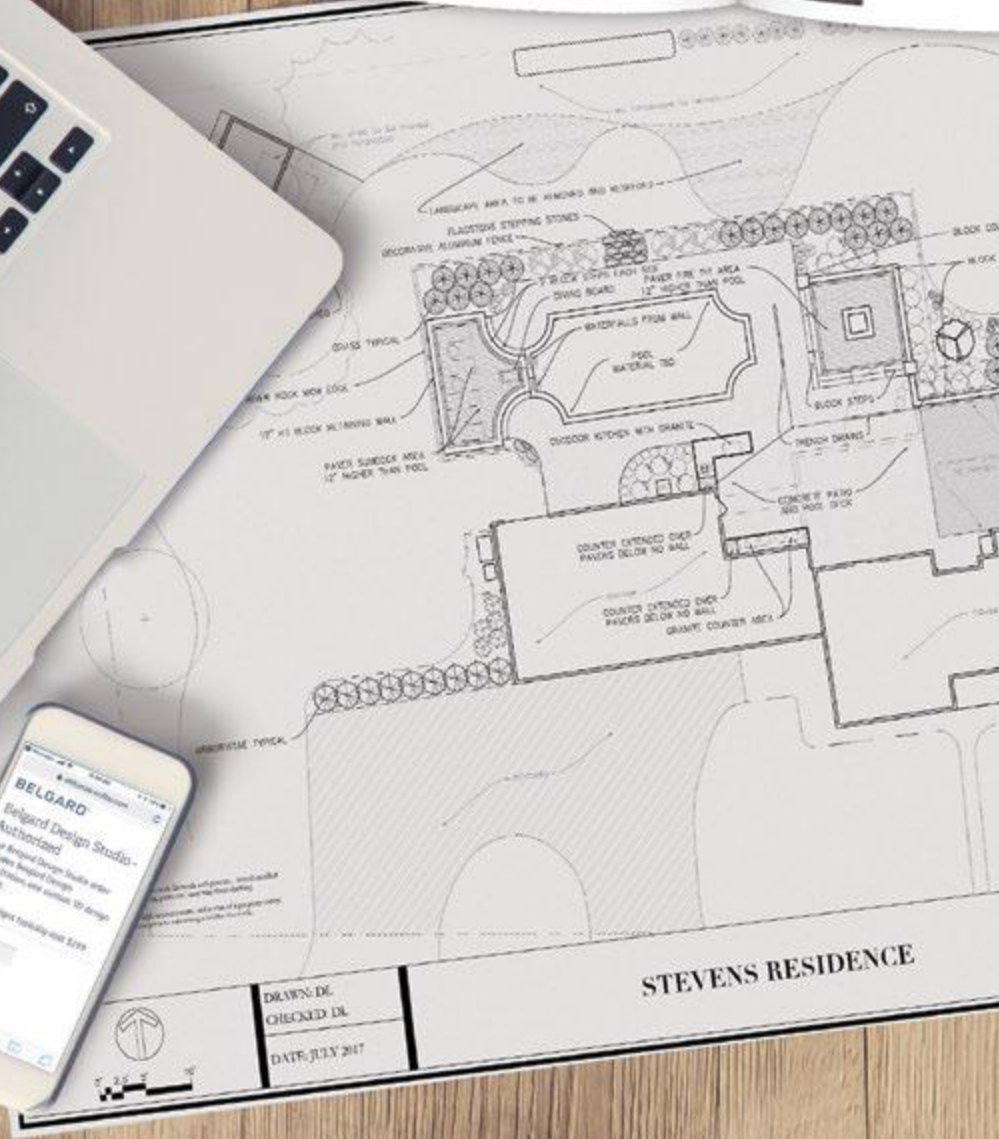

LAFITT PAVER







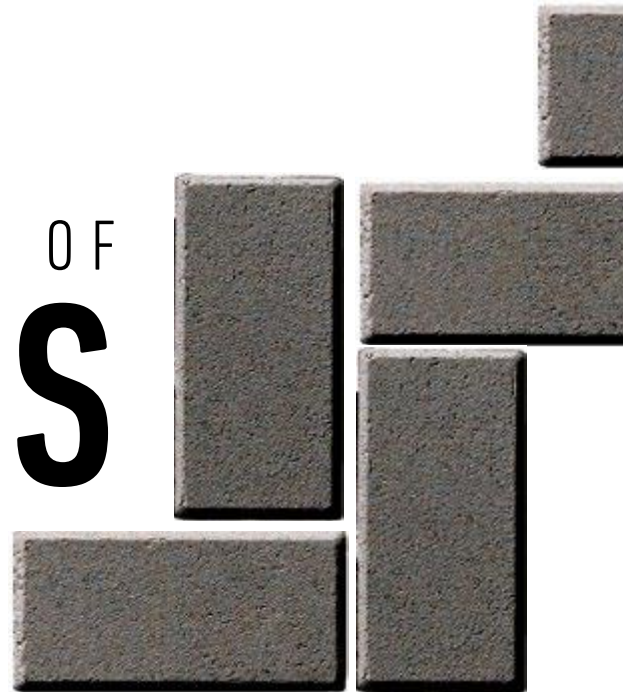

YOUR JOURNEY STARTS HERE

TABLE OF CONTENTS



4	Style Guide
16	Inspiration
 34	Pavers & Slabs
 94	Walls
 116	Fire Features
 128	Accessories

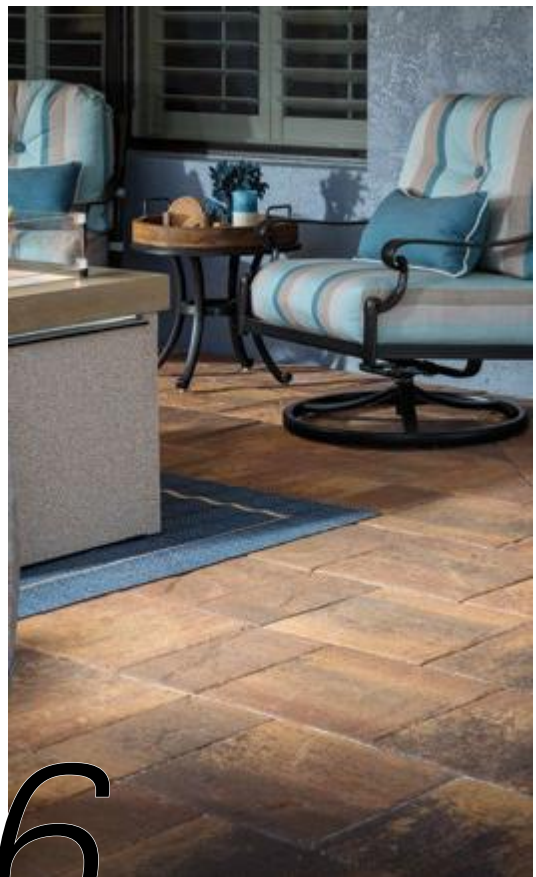

56

Lafitt Rustic Slab

NOTE: Belgard® can not guarantee printed color swatches will match actual product. All colors shown are approximate representations of the standard product. Actual colors may vary slightly due to batch variances and environmental conditions at time of photography. Actual sizes may vary by region. Please contact your local Belgard representative for accurate samples, availability and pricing.



98

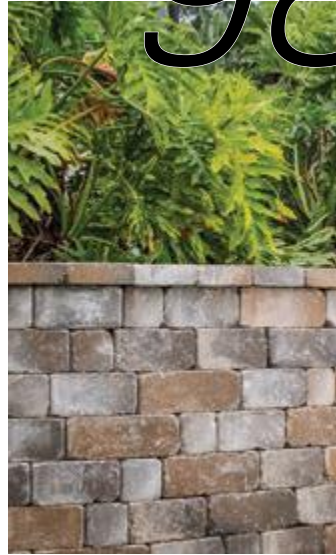

Castlemanor

82



Quarziti 2.0



Holland Stone

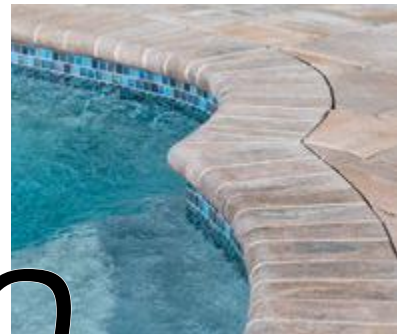

Bullnose Coping

130

TIMELESS & TRENDING





THE ESSENCE OF OUTDOOR LIVING.

The primary goal in designing an outdoor living room is to create a space that invites you to spend time outdoors. Whether you enjoy entertaining large groups or prefer an intimate space for curling up with a good book, Belgard® is your source for patio designs that bring the outdoors to life.



Follow Belgard on Pinterest at
[Pinterest.com/Belgard](https://www.pinterest.com/Belgard)

**RANDOM EDGE
SILHOUETTES ARE
RETURNING TO FOCUS IN
CONTEMPORARY WAYS**

Pictured: Mega-Arbel Patio Slab



NATURAL CONNECTION. CONTEMPORARY FOCUS.



**ENTANGLEMENT
BETWEEN PAVERS
AND NATURAL
LANDSCAPES IS A
GROWING DESIGN TREND.**

Pictured: Turfstone



**ESCAPE TO
THE ELEMENTS**

Current nature-led trends are inspired by blending raw nature and earthen landscapes with the contemporary built environment. This evolution adds a more organic, rugged and imperfect aesthetic.

*Pictured: Custom
Weston Stone Fire Pit
Mega-Arbel Patio Slab*

BACK TO NATURE

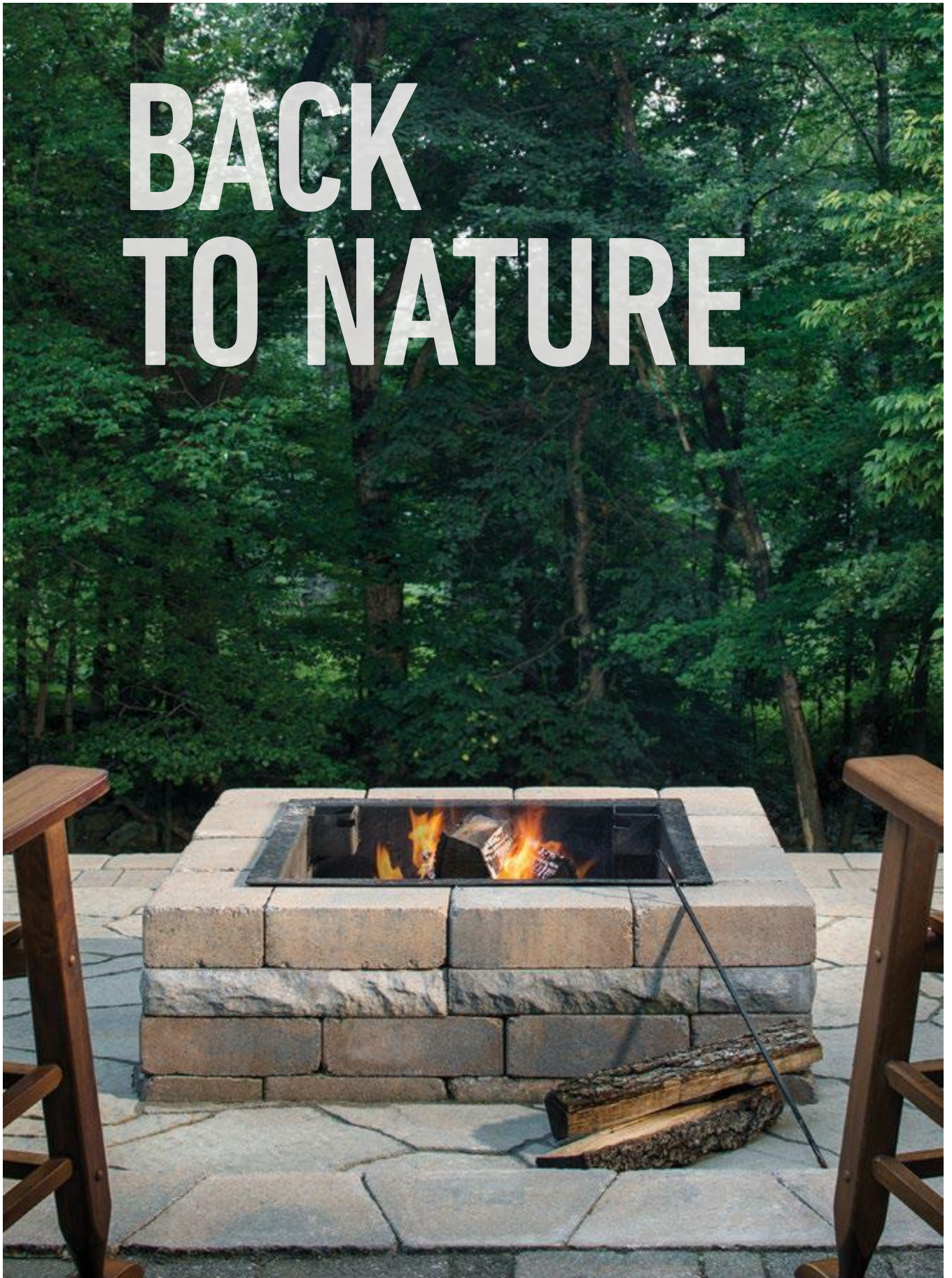

STYLISH ROOMSCAPES





DISPLAY YOUR VIEW. NO FRAME REQUIRED.

*Pictured: Mega Bergerac, Bergerac Circle border,
Dublin Cobble Circle, Country Manor Wall and
Mega-Arbel Patio Slab*



STAY INSPIRED.
SEE MORE ROOMSCAPES
@ PINTEREST.COM/BELGARD

LIVE WITHOUT BOUNDARIES

Outdoor settings become rooms without roofs – no longer just dining areas on decks. Create outdoor social spaces to entertain, work, play and relax.

Pictured: Holland Stone



FINE DINING ONLY A FEW STEPS AWAY

Pictured: Bergerac, Old York & Weston Stone



With dozens of styles, colors, shapes and textures to choose from, Belgard® products help you create outdoor living spaces that become an outward expression of your personal sense of style.

STYLE MADE SIMPLE

BLENDS

TITANIUM



NAPOLI



AMARETTO



SLATE



TUSCANY



ADOBE



KNIGHTSBRIDGE



BROWN-CHESTNUT



HARVEST BLEND

SLATE/RUSTIC



SCULPTED



COBBLED



DIMPLED



SMOOTH/GRANA



COLORS

SOLIDS

CREAM



CAMEL



CHARCOAL



MALT



CHESTNUT



GRAY

TEXTURES

TRENDING & TIMELESS TIP

GO 'GREIGE'

The year's most sought after neutral isn't going out of style any time soon.

Its beauty is in its versatility. The addition of gray to beige creates a richer hue that can work in a cool or warm color scheme, meaning your hardscapes will continue to coordinate with evolving styles.



STANDARD



DISTRESSED



TUMBLED

SCALE



4" X 8"
HOLLAND STONE

15 3/8" X 20 1/16"
MEGA-ARBEL®



12" X 3"
MODULINE SERIES®

5" X 11 13/16"
AGILINA™ PLANK

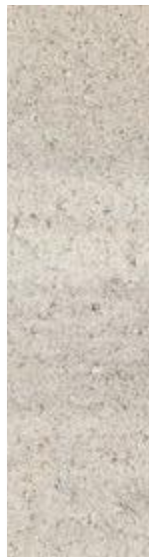

6" X 9"
CATALINA®



Old York



PROVIDE VERTICAL INTEREST

Pictured: Ashlar Tandem Column Kit, Moduline (banding), and Esplanade cap

 **STAY INSPIRED.**
SEE MORE BORDER INSPIRATION
@ PINTEREST.COM/BELGARD



DEFINE YOUR SPACE

Incorporating multiple styles is a great way to segment your outdoor living areas into rooms without roofs. Adding a sleek border with a more natural stone, like in the image at right, creates the cozy feeling of a hearth rug in front of the fireplace.

Pictured: Highland Stone, Lafitt Paver, Holland Stone (border) and Mega-Arbel Patio Slab (hearth rug)



CREATE A WARM WELCOME

Pictured: Mega-Bergerac and Bergerac (rug detail)

BREAK FROM THE NORM

Pictured: Belair Wall 2.0, Lafitt Rustic Slab and Holland Stone (borders & banding)



MIX TEXTURES

From sleek contemporary to the look of cut slate Belgard offers a variety of textures to play with. Go for a monochrome look, like in the image at right, to maximize the tactile experience without overwhelming the eye.

Pictured: Lafitt Grana, Mega-Arbel Patio Slab (walkway) and Old World Paver (border)



ADD ACCENTS TO MAKE THE ORDINARY EXTRAORDINARY

Pictured: Moduline Series



BORDERS & BANDING



BUILD COLUMNS IN A SNAP

Tandem® Column Kit is an innovative, versatile system that can be used to create attractive, easy-to-install and durable columns. Great for use in residential and light commercial hardscape projects.

WALL IT OFF WITH U START

One of Belgard's latest innovations, U Start Base Block® is a universal base course for landscaping walls that promotes cost savings and installation time efficiency.

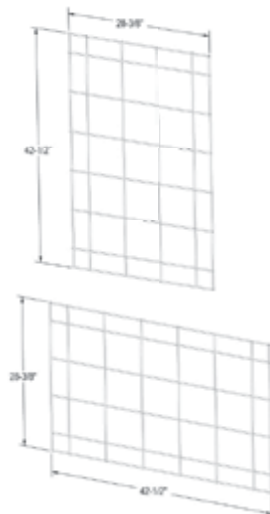

TANDEM® MODULAR GRID GIVES YOU ENDLESS POSSIBILITIES

Construct virtually any design up to 7' tall by simply attaching the grids to a wooden structure and connecting the veneers. Build an outdoor kitchen, skirt a deck, run electrical for lighting/sound, construct seat walls... the possibilities are endless.

INSTALLATION INNOVATIONS

PRODUCTS THAT MAKE INSTALLATION EASIER

Belgard® offers several products designed to make installation easier and more efficient. Why spend more time and money when you don't have to?

PICTURED: TANDEM COLUMN KIT



LET US
INSPIRE YOU.





MAKE A SPLASH





TOP
Catalina

BOTTOM
Lafitt Rustic Slab
Bullnose Coping

OPPOSITE
Porcelain Veneer

PAVERS COPING WALLS

Whether bringing new life to an old pool or installing a new one, Belgard® pavers and wall products can help you create stunning poolscapes that go beyond the water's edge to connect all of your outdoor spaces into one flowing design.



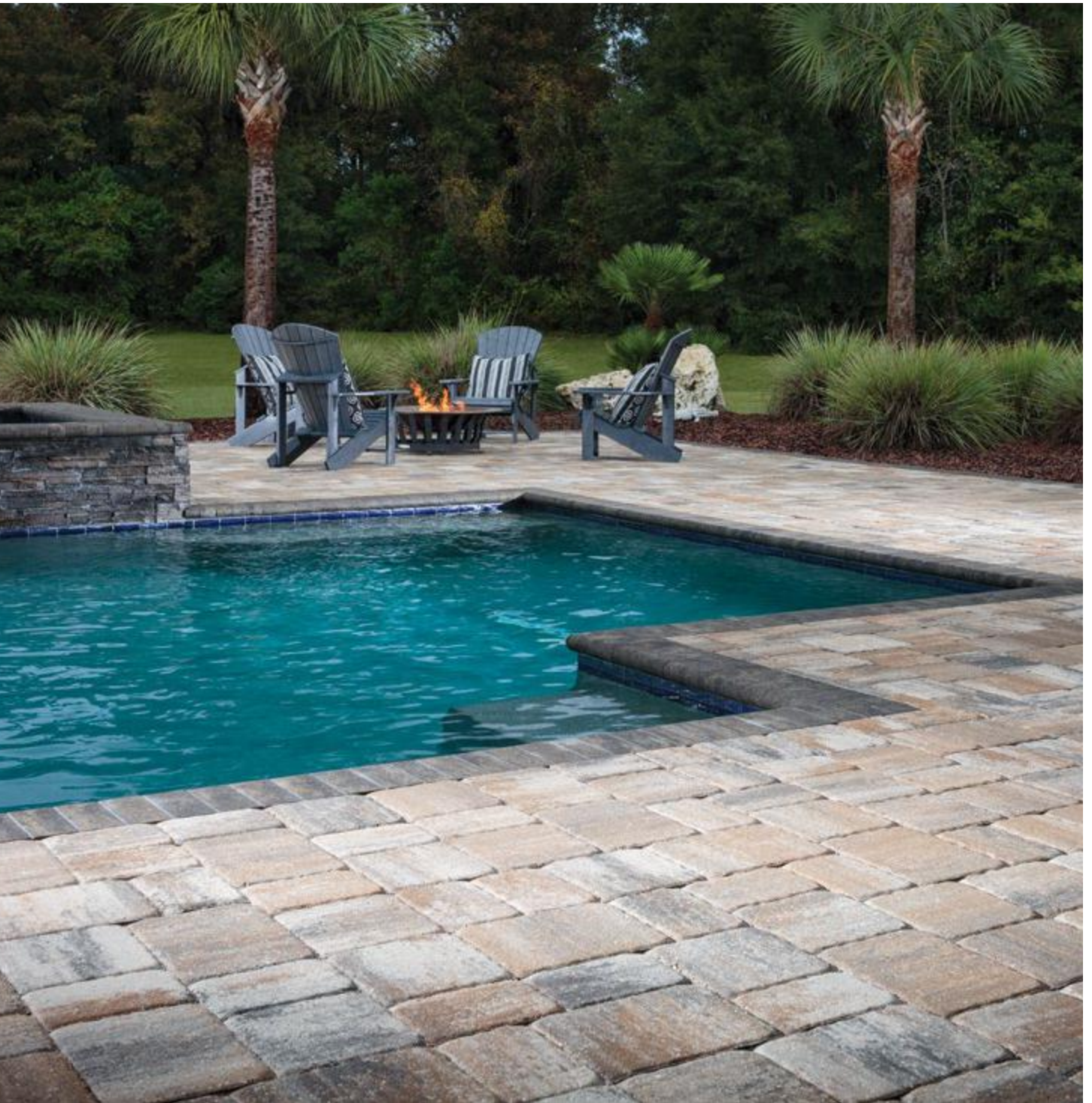

TOP
Mega-Cambridge
Bullnose Coping

OPPOSITE
Turin Porcelain Pavers



TOP
Mega-Cambridge
Castlemanor

BOTTOM
Appian-Stone
Weston Stone
Bristol Series Fireplace & Wood Boxes

OPPOSITE
Lafitt Rustic Slab
Ashlar Tandem
Bordeaux Series Fireplace & Wood Boxes



COZY UP ENTERTAIN MAKE MEMORIES

With Belgard®, you can create outdoor living rooms that become the hub of activity for your family. Imagine roasting marshmallows over a crackling fire or cuddling up on a cool fall evening in front of the hearth. Now that's living.

CREATE A SPARK







TOP
Appian-Stone
Weston Stone Fire Pit
Bullnose Coping

OPPOSITE
Mega-Cambridge
Castlemanor
Brighton Series Fireplace & Wood Boxes

TAKE LIFE OUTSIDE





TOP

Appian-Stone
Weston Stone

BOTTOM

Cambridge Cobble
Weston Stone

OPPOSITE

Cambridge Cobble
Bullnose Coping

FAMILY FRIENDS FUN

When you create an outdoor living room, you can be sure it will not only be filled with life, but with moments that last a lifetime. Whether hosting an impromptu dinner party, inviting the neighbors over, or just spending some quality time with your family, Belgard® is your source for beautiful outdoor designs.



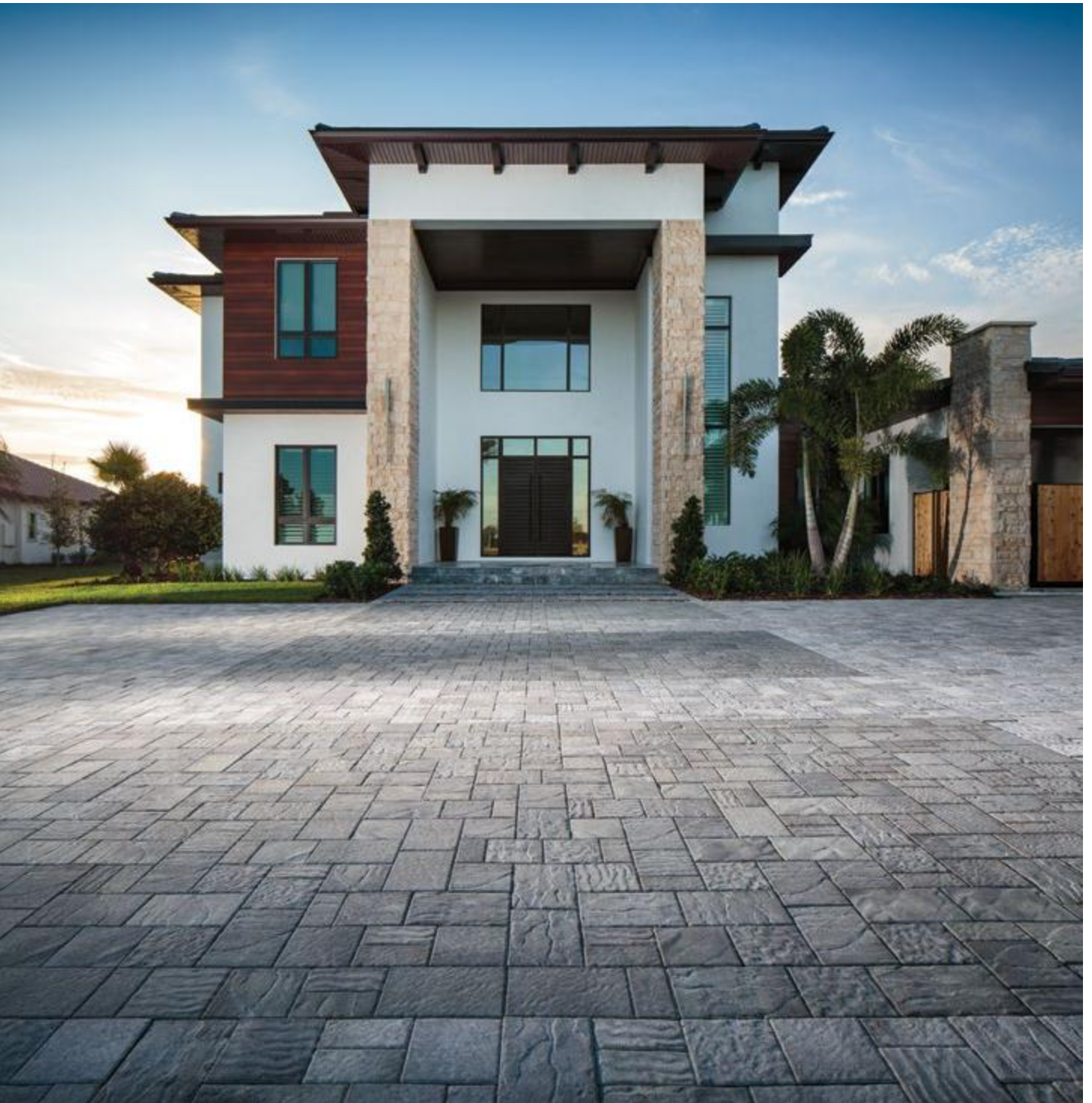

TOP
Catalina

OPPOSITE
Appian-Stone
Weston Stone



TOP
Appian-Stone
Weston Stone

BOTTOM
Mega-Cambridge
Bullnose Coping

OPPOSITE
Turin Porcelain Pavers



BEAUTY RELAXATION SERENITY

An inviting outdoor retreat provides a mix of beautiful flora, shady nooks and areas to relax or entertain. Take it a step further with hardscaped pathways or a water feature.

BUILD AN OASIS

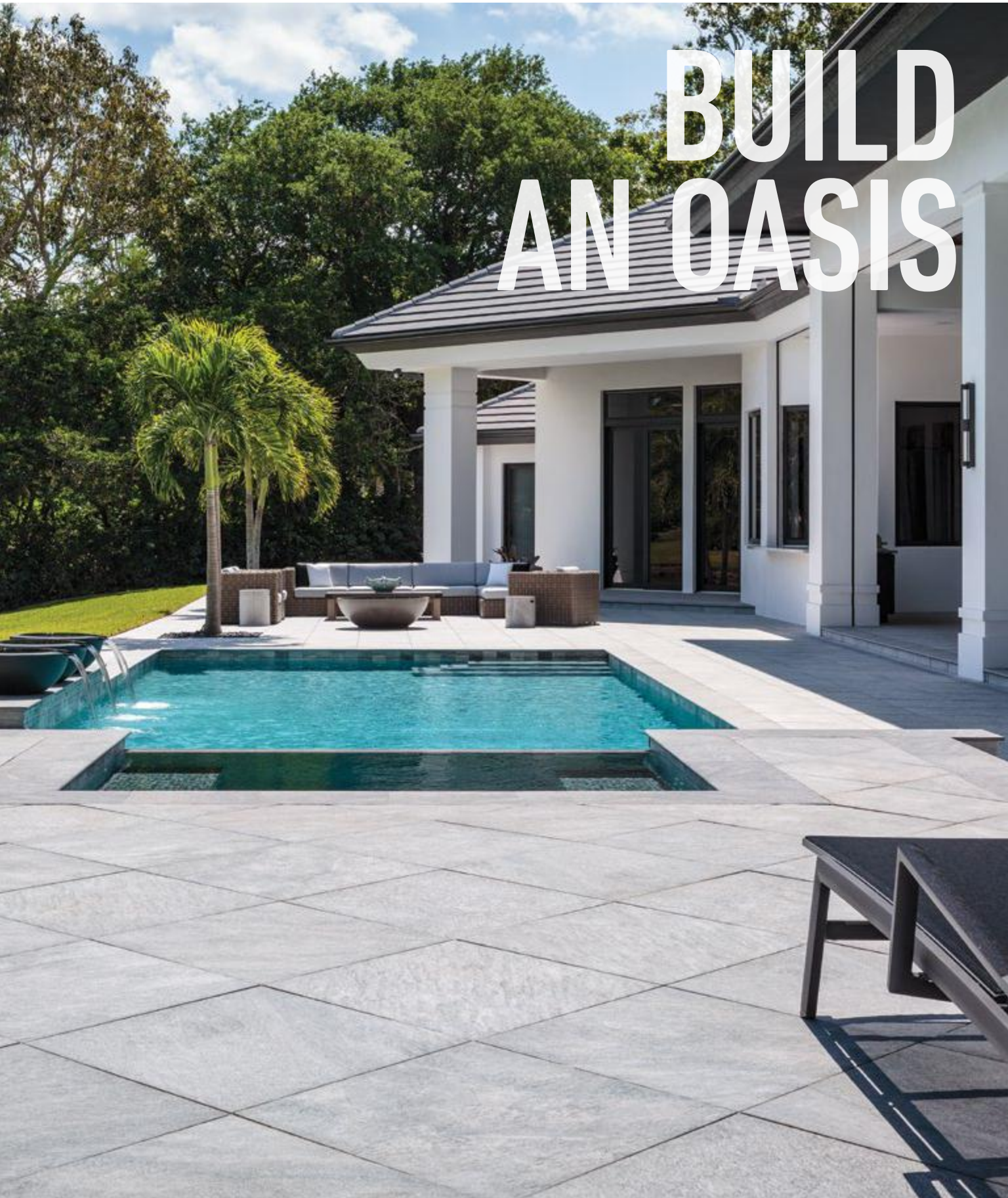

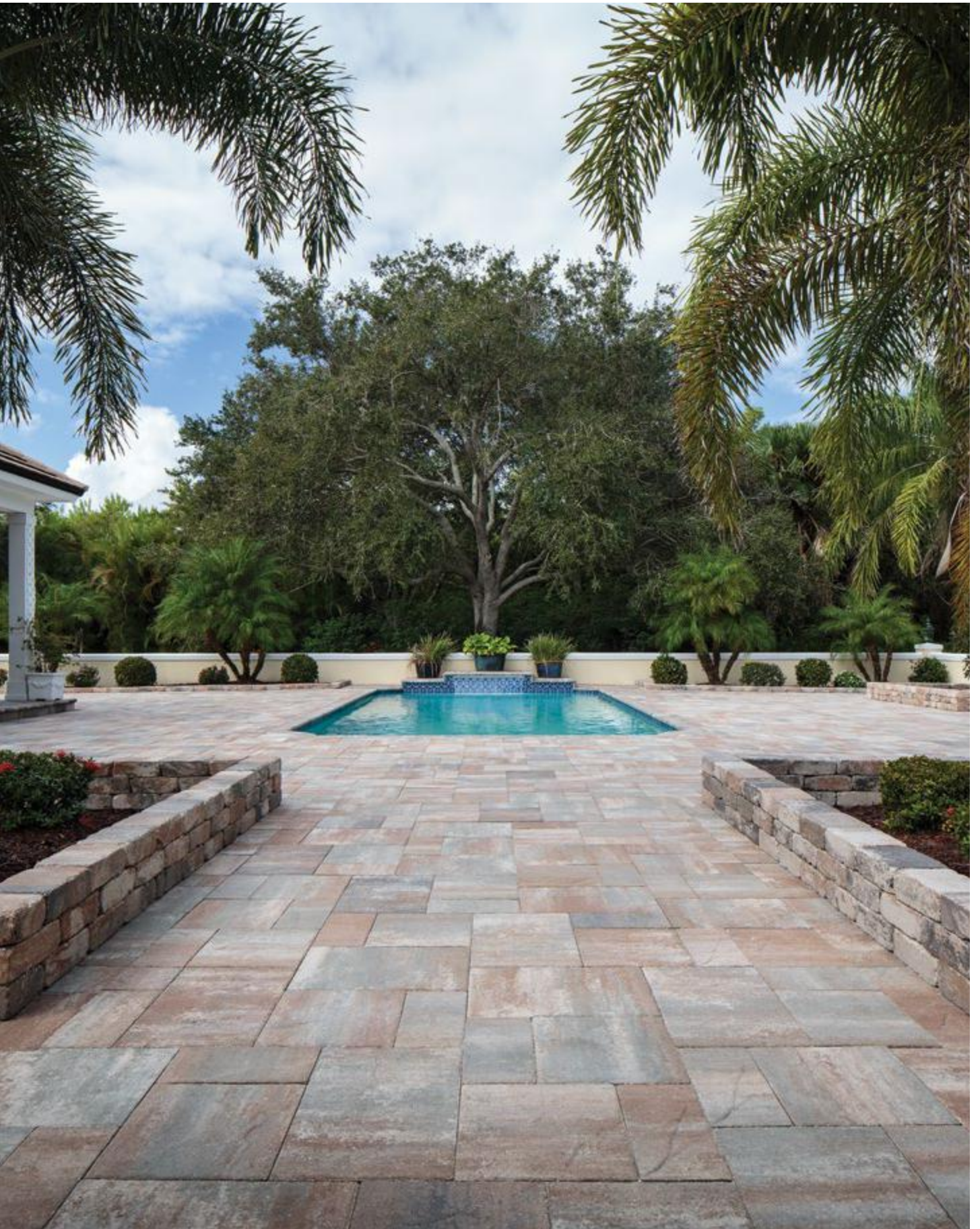



TOP

Mega-Arbel

Bristol Series Brick Oven

Weston Stone Grill Island with Arbel accent

OPPOSITE

Lafitt Rustic Slab

Weston Stone

Bullnose Coping



PAVERS & SLABS

- NEW 36** Agilina™ Plank
- 38** Appian-Stone®
- 40** Belgian Cobble® 
- 42** Cambridge Cobble®
- 44** Catalina™
- 46** City Series
- 48** Clay Paver
- 50** Dublin Cobble®
- 52** Holland Stone
- NEW 54** Lafitt® Grana Slab
- 56** Lafitt® Rustic Slab
- 58** Mega-Arbel®

- 60** Mega-Bergerac®
- 62** Mega-Cambridge™
- 64** Mega-Lafitt®
- 66** Moduline Series®
- 68** Oceanside
- 70** Old World Paver™ 

PERMEABLE

- 72** Aqua-Bric® 
- 73** Eco-Holland® 
- 74** Eco-Priora™ 
- 75** StormPave 
- 76** Turfstone™ 
- 77** Uni Eco-Stone® 

PORCELAIN

- 78** Ardesie
- 79** Esprit
- 80** Na.Me
- 82** Quarziti 2.0
- 83** Stones 2.0
- NEW 84** Turin
- NEW 86** Verona
- 87** Nau
- 88** Noon
- 89** Sundeck
- 90** Unico
- NEW 92** Porcelain Veneer

LEGEND



WALKWAYS



PATIOS



POOLS



DRIVEWAYS



PERMEABLE



PAVERS + SLABS

CLASSIC CONTEMPORARY STONE TEXTURE

Create eye-catching walkways, patios and driveways that express your personal sense of style. Belgard® pavers are strong, durable and environmentally friendly, helping you create beautiful spaces that will stand the test of time. You pick the look.

WE'LL PAVE THE WAY



Pictured: Agilina Plank

OLD WORLD PAVER

NEW

AGILINA™ PLANK

PAVERS

Inspired with a distinctive natural stone look, Agilina pavers are ideal for projects that merge the old-world aesthetics with a more contemporary look, thanks to the multiple widths, that can be mixed together to achieve random patterns.



AVAILABLE COLORS



Amaretto



Napoli

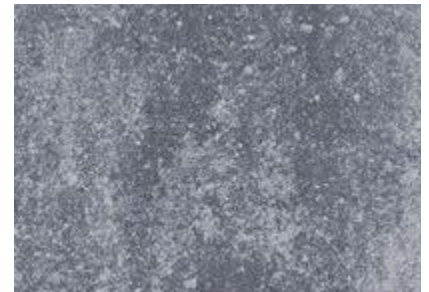

Slate

SHAPES & SIZES

3-Piece



5 x 11 $\frac{3}{4}$ x 2 $\frac{3}{8}$



5 x 15 $\frac{3}{4}$ x 2 $\frac{3}{8}$

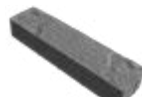

5 x 19 $\frac{3}{4}$ x 2 $\frac{3}{8}$



APPIAN-STONE®

PAVERS / TILES



Named for Europe's famous Appian Way, these pavers give your hardscape a natural look and feel that evokes another age. Suitable for pedestrian and vehicular traffic.

AVAILABLE COLORS



Adobe



Amaretto



Brown-Chestnut



Harvest Blend



Knightsbridge



Napoli



Slate



Titanium



Tuscany

SHAPES & SIZES

2-Piece 60mm



6 x 6 x 2³/₈



6 x 9 x 2³/₈

2-Piece 80mm



6 x 6 x 3¹/₈



6 x 9 x 3¹/₈

Rectangle 60mm

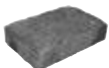

6 x 9 x 2³/₈

Tile 2-Piece 30mm*



6 x 6 x 1³/₁₆



6 x 9 x 1³/₁₆

*30mm not recommended for vehicular use.



DRIBOND™ & BORDERBOND™

DriBond is a revolutionary product specially designed for the overlay of thin pavers (1" or 30mm) on existing concrete. It can be installed quickly and easily over most sound concrete surfaces. Please refer to page 140 for more information.



BELGIAN COBBLE®

PAVERS



Belgian Cobble creates picturesque walkways, driveways, patios and poolsapes with a multi-piece system that looks like natural stone pulled from the bed of a mountain creek. Belgian Cobble can be installed as either a standard or permeable paver system.



AVAILABLE COLORS



Grey



Slate

SHAPES & SIZES

Multi-Piece 70mm



Variable x 2¾"

With proper base and joint material, Belgian Cobble can be used as a permeable product.



CAMBRIDGE COBBLE®

PAVERS / TILES



The versatile Cambridge Cobble offers a tailored, architectural look with gently rounded corners and a domed pillowtop surface. The subtle color combinations and multiple pattern options make it ideal for crafting intricate designs.

AVAILABLE COLORS



Adobe



Amaretto



Brown-Chestnut



Harvest Blend



Knightsbridge



Napoli



Slate



Titanium



Tuscany

Swatches represent product color only, not surface texture, dimensions or shape.

SHAPES & SIZES

3-Piece 60mm



3 x 6 x 2³/₈



6 x 6 x 2³/₈



6 x 9 x 2³/₈

3-Piece Tile 30mm*



3 x 6 x 1³/₁₆



6 x 6 x 1³/₁₆



6 x 9 x 1³/₁₆

*30mm not recommended for vehicular use.



DRIBOND™ & BORDERBOND™

DriBond is a revolutionary product specially designed for the overlay of thin pavers (1" or 30mm) on existing concrete. It can be installed quickly and easily over most sound concrete surfaces. Please refer to page 140 for more information.



CATALINA™

PAVERS / TILES



Catalina combines the flexibility of modular design with the textured finish of natural slate. The three-piece system is available in three thicknesses for increased design flexibility.

AVAILABLE COLORS



Amaretto



Harvest Blend



Napoli



Slate



Titanium

SHAPES & SIZES

3-Piece Tile 30mm*



4 x 8 x 1 3/8



8 x 8 x 1 3/8



8 x 12 x 1 3/8

3-Piece 60mm



4 x 8 x 2 3/8



8 x 8 x 2 3/8



8 x 12 x 2 3/8

*30mm not recommended for vehicular use.

3-Piece 80mm



4 x 8 x 3 3/8



8 x 8 x 3 3/8



8 x 12 x 3 3/8



DRIBOND™ & BORDERBOND™

DriBond is a revolutionary product specially designed for the overlay of thin pavers (1" or 30mm) on existing concrete. It can be installed quickly and easily over most sound concrete surfaces. Please refer to page 140 for more information.



CITY SERIES

PAVERS / TILES



The array of patterns that you can create with the City Series is truly dazzling. With a large selection of colors and sizes, the possibilities are endless.

AVAILABLE COLORS



Amaretto



Harvest Blend



Napoli



Slate



Titanium

SHAPES & SIZES

12x12 Tile 30mm*



12 x 12 x 1 $\frac{3}{16}$ "

8x8 60mm



8 x 8 x 2 $\frac{3}{16}$ "

8x12 60mm



8 x 12 x 2 $\frac{3}{16}$ "

12x12 60mm



12 x 12 x 2 $\frac{3}{16}$ "

*30mm not recommended for vehicular use.



DRIBOND™ & BORDERBOND™

DriBond is a revolutionary product specially designed for the overlay of thin pavers (1" or 30mm) on existing concrete. It can be installed quickly and easily over most sound concrete surfaces. Please refer to page 140 for more information.



CLAY PAVER

PAVERS



Discover the versatility and beauty of Clay Pavers. Perfect for patios, walkways, driveways, steps and pools. Customize your outdoor space with decorative patterns, textures and the rich colors that this durable brick paver has to offer.



AVAILABLE COLORS



Courtyard - Full Range



Georgian Edge - Full Range



Georgian Edge - Red

This product is also available in Canterra & Harvest. Please contact your local sales representative for more information.

SHAPES & SIZES

Clay Paver 60mm



4 x 8 x 2 $\frac{3}{8}$



DUBLIN COBBLE®

PAVERS



A true classic, the gently distressed surface and antiqued edging of Dublin Cobble creates a casually elegant, time-worn look.



AVAILABLE COLORS



Amaretto



Harvest Blend



Napoli

Swatches represent product color only, not surface texture.

SHAPES & SIZES

3-Piece 60mm



3 x 6 x 2³/₈

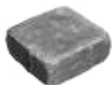

6 x 6 x 2³/₈



6 x 9 x 2³/₈

Large Square 60mm



9 x 9 x 2³/₈



HOLLAND STONE

PAVERS / TILES



The classic shape, smooth surface and multiple color options make Holland Stone ideal for creating a wide variety of traditional looks. Holland Stone is also an excellent choice as a border element.

AVAILABLE COLORS



Adobe



Amaretto

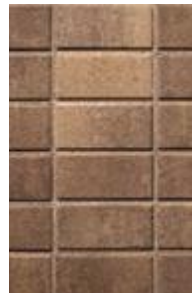

Brown-Chestnut

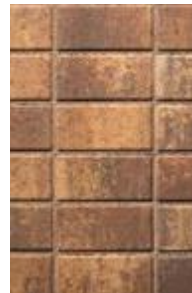

Harvest Blend

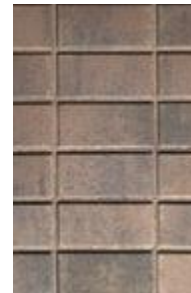

Knightsbridge

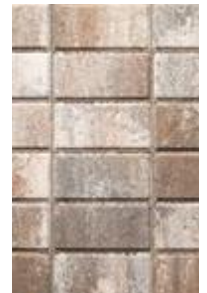

Napoli



Slate



Titanium



Tuscany

SHAPES & SIZES

Holland Stone Tile
30mm*



4 x 8 x 1³/₁₆

Holland Stone 60mm



4 x 8 x 2³/₈

Holland Stone 80mm



4 x 8 x 3¹/₈

Holland Stone 100mm



4 x 8 x 4

*30mm not recommended for vehicular use.
60, 80 & 100mm available in tumbled.



DRIBOND™ & BORDERBOND™

DriBond is a revolutionary product specially designed for the overlay of thin pavers (1" or 30mm) on existing concrete. It can be installed quickly and easily over most sound concrete surfaces. Please refer to page 140 for more information.



NEW LAFITT® GRANA SLAB PAVERS

Lafitt Grana Slab pairs sleek contemporary style with modern durability and design innovation. These pavers create beautiful patios and walkways that are barefoot friendly.



AVAILABLE COLORS



Amaretto



Harvest Blend



Napoli



Slate



Titanium

Swatches represent product color only, not surface texture, dimensions or shape.

SHAPES & SIZES

3-Piece 50mm*

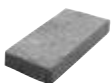

7 $\frac{7}{8}$ x 14 $\frac{7}{8}$ x 2



14 $\frac{7}{8}$ x 14 $\frac{7}{8}$ x 2



14 $\frac{7}{8}$ x 22 $\frac{5}{8}$ x 2

*Products are not recommended for vehicular use.



LAFITT® RUSTIC SLAB

PAVERS



Lafitt Rustic slab features the look and texture of cut slate paired with the versatility of large-scale modular design.



AVAILABLE COLORS



Amaretto



Harvest Blend



Napoli



Slate



Titanium

Swatches represent product color only, not surface texture, dimensions or shape.

SHAPES & SIZES

3-Piece 50mm*

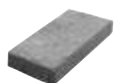

7 $\frac{3}{8}$ x 14 $\frac{7}{8}$ x 2

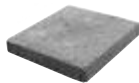

14 $\frac{7}{8}$ x 14 $\frac{7}{8}$ x 2

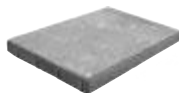

14 $\frac{7}{8}$ x 22 $\frac{5}{16}$ x 2

*Products are not recommended for vehicular use.



MEGA-ARBEL®

SLABS



Mega-Arbel slab offers the look and feel of natural flagstone. With an irregular shape and virtual joints, it creates a random look that flows harmoniously into the surrounding landscape.



AVAILABLE COLORS

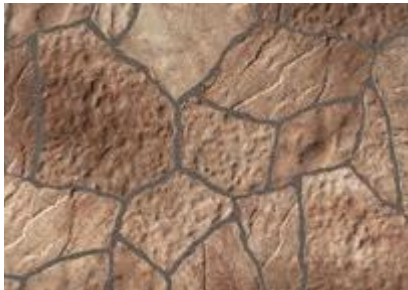

Amaretto



Harvest Blend

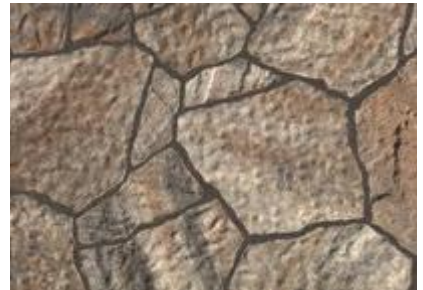

Napoli

SHAPES & SIZES

Mega-Arbel 60mm



15 $\frac{3}{8}$ x 21 x 2 $\frac{3}{8}$



MEGA-BERGERAC®

PAVERS



Bring old-world European charm to modern design with the timeless, hand-cobbled look of Mega-Bergerac, which features a dimpled surface, weathered edges and an array of distinctive color blends.



AVAILABLE COLORS



Amaretto



Harvest Blend



Napoli

SHAPES & SIZES

3-Piece 80mm



4¾ x 9½ x 3⅞



9½ x 9½ x 3⅞



9½ x 14¼ x 3⅞

Large Square 80mm

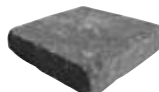

14¼ x 14¼ x 3⅞



MEGA-CAMBRIDGE™

PAVERS / TILES



The old world look meets low maintenance, modern durability in Mega-Cambridge pavers. These pavers give your hardscape a natural look and feel that evokes another age.

AVAILABLE COLORS



Amaretto



Harvest Blend



Napoli



Slate



Titanium

SHAPES & SIZES

3-Piece Tile 30mm*



6 x 9 x 1 $\frac{3}{16}$ "



9 x 9 x 1 $\frac{3}{16}$ "



9 x 12 x 1 $\frac{3}{16}$ "

*30mm not recommended for vehicular use.

3-Piece 60mm



6 x 9 x 2 $\frac{3}{8}$ "



9 x 9 x 2 $\frac{3}{8}$ "



9 x 12 x 2 $\frac{3}{8}$ "

3-Piece 80mm

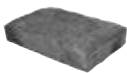

6 x 9 x 3 $\frac{1}{8}$ "



9 x 9 x 3 $\frac{1}{8}$ "

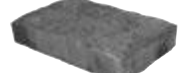

9 x 12 x 3 $\frac{1}{8}$ "



DRIBOND™ & BORDERBOND™

DriBond is a revolutionary product specially designed for the overlay of thin pavers (1" or 30mm) on existing concrete. It can be installed quickly and easily over most sound concrete surfaces. Please refer to page 140 for more information.



MEGA-LAFITT®

PAVERS



Mega-Lafitt features one of the most natural-looking textures available in a modular paver, combining the look and feel of cut flagstone with the strength and durability of Belgard®.



AVAILABLE COLORS



Napoli



Slate



Titanium

SHAPES & SIZES

3-Piece 80mm



5¼ x 10½ x 3⅜



10½ x 10½ x 3⅜



10½ x 15¾ x 3⅜

Large Square 80mm

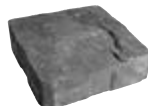

15¾ x 15¾ x 3⅜



MODULINE SERIES®

PAVERS / PLANKS



One of the most versatile paver systems available, Moduline Series comes in a wide array of colors, sizes and shapes to use as an accent or border to create unique contemporary designs.

AVAILABLE COLORS



Charcoal

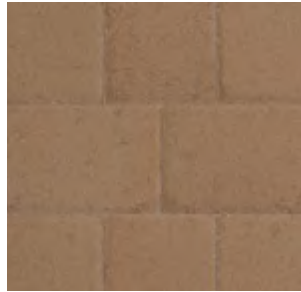

Chestnut



Cream



Napoli

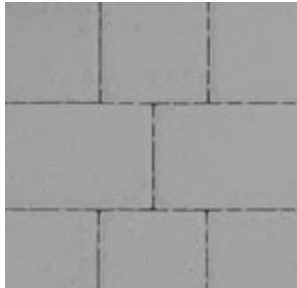

Pewter



Slate



Titanium

Swatches represent product color only, not surface texture, dimensions or shape.

SHAPES & SIZES

3x12 60mm



3 x 12 x 2³/₈

3x12 80mm



3 x 12 x 3¹/₈

3x12 100mm



3 x 12 x 4

4x12 100mm



4 x 12 x 4

4x16 100mm



4 x 16 x 4

6x12 60mm



6 x 12 x 2³/₈

6x12 80mm



6 x 12 x 3¹/₈

12x12 60mm



12 x 12 x 2³/₈

12x24 60mm



12 x 24 x 2³/₈

2-Piece 80mm



4 x 12 x 3¹/₈



4 x 16 x 3¹/₈



OCEANSIDE

PAVERS / TILES



Oceanside pavers combine coquina and oyster shells with a truly durable product for a level of natural beauty few pavers can match.



AVAILABLE COLORS



Camel



Cream



Gray



Malt



White

SHAPES & SIZES

See page 134 for matching coping products.

4x8 30mm*



4 x 8 x 1³/₁₆

12x12 30mm*

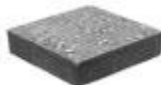

12 x 12 x 1³/₁₆

4x8 60mm



4 x 8 x 2³/₈

8x8 60mm

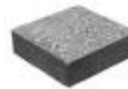

8 x 8 x 2³/₈

8x12 60mm



8 x 12 x 2³/₈

12x12 60mm



12 x 12 x 2³/₈

16x16 60mm*

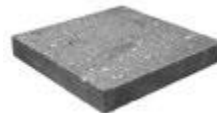

16 x 16 x 2³/₈

*Products not recommended for vehicular use.



DRIBOND™ & BORDERBOND™

DriBond is a revolutionary product specially designed for the overlay of thin pavers (1" or 30mm) on existing concrete. It can be installed quickly and easily over most sound concrete surfaces. Please refer to page 140 for more information.



OLD WORLD PAVER™

PAVERS



Reminiscent of the cobbled streets of Europe, Old World Paver is crafted with a natural stone cleft finish for the look and feel of time-worn stone. Ideal for high traffic areas or for use as a border. Old World Paver can be installed as either a standard or permeable paver system.



AVAILABLE COLORS



Napoli



Slate



Titanium

SHAPES & SIZES

3-Piece 80mm



5 x 8 x 3/8



5 x 10 x 3/8

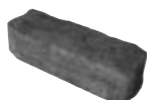

5 x 13 x 3/8

With proper base and joint material, Old World Paver can be used as a permeable product.



AQUA-BRIC®

PERMEABLE PAVERS



Basic in form, with a clean, modular shape, Aqua-Bric permeable pavers are an attractive and practical choice; easily adaptable with a wide range of design options.



AVAILABLE COLORS



Adobe*



Napoli



Slate*

*Swatches represent product color only, not shape.

SHAPES & SIZES

Aqua-Bric 80mm

Aqua-Bric Type Four (Mechanical)



5 x 10 x 3/8"



5 x 10 x 3/8"

ECO-HOLLAND®

PERMEABLE PAVERS



The classic shape, smooth ADA-compliant surface and multiple color choices make Eco-Holland a highly versatile option for an array of outdoor living applications, including high-traffic areas and driveways.



AVAILABLE COLORS



Adobe



Napoli*



Slate

*Swatches represent product color only, not shape.

SHAPES & SIZES

Eco-Holland 80mm



4 x 8 x 3 1/8"

Eco-Holland II 80mm (Mechanical)



4 x 8 x 3 1/8"

ECO-PRIORA™

PERMEABLE PAVERS



With its unique, patented interlocking spacers, Eco-Priora provides secure structural performance for permeable interlocking concrete pavements (PICP's).



AVAILABLE COLORS



Adobe



Napoli*



Slate

*Swatches represent product color only, not shape.

SHAPES & SIZES

Eco-Priora Rectangle
60mm



4 x 8 x 2 $\frac{3}{8}$

Eco-Priora Square
60mm



8 x 8 x 2 $\frac{3}{8}$

STORMPAVE

CLAY PERMEABLE PAVERS



StormPave clay permeable pavers provide an environmentally friendly option for preserving natural water drainage through a classic segmental pavement. StormPave features large spacers for open joint drainage and a maximum opening of less than 1/2".



AVAILABLE COLORS



Courtyard -Full Range

Also available in Harvest Blend & Siesta



Georgian Edge -Full Range



Georgian Edge -Red

SHAPES & SIZES

StormPave 60mm



4 x 8 x 2³/₄

TURFSTONE™

PERMEABLE PAVERS



Turfstone stabilizes soil erosion by allowing rainwater to gradually filter back into soil. Its eco-friendly design reduces run-off while allowing greenery to grow through it, creating a unique natural look.



AVAILABLE COLORS

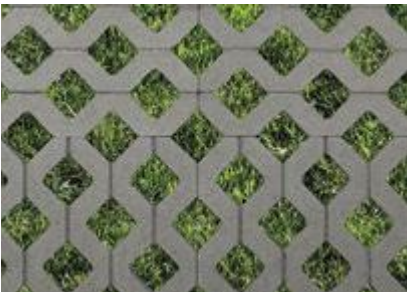

Gray

SHAPES & SIZES

Turfstone



15¼ x 23⅝ x 3⅞

UNI ECO-STONE®

PERMEABLE PAVERS



Uni Eco-Stone is designed to handle heavy traffic, making it ideal for a wide range of applications. Whether your plans include a pool deck, patio or driveway, it's an attractive yet environmentally sound choice for its ability to allow water to permeate the surface of the paver.



AVAILABLE COLORS



Adobe



Napoli



Slate

Swatches represent product color only, not shape.

SHAPES & SIZES

Uni Eco-Stone 80mm



4 x 9 x 3 1/8

ARDESIE

STONE FINISH PORCELAIN PAVERS



Ardesie captures the elegance of natural stone in a contemporary way. The end result is a slate-like look with the durability of porcelain. Expect the wide range of color variation that is inherent in natural slate.



AVAILABLE COLORS



African Stone
AD 03 NAT - V4

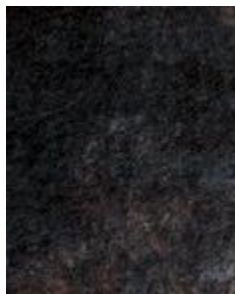

Black Reef
AD 04 NAT - V3



Island
AD 02 NAT - V3



SPECIAL ORDER

Shore
AD 01 NAT - V3



Vulcan
AD 05 NAT - V3

SHAPES & SIZES



23.54 x 23.54 x 3/4

UNICO

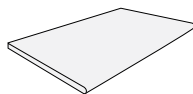

12.99 x 23.54 x 3/4

See page 90 for full product information.



Spacers are recommended for all porcelain paver installations. PLEASE NOTE: For vehicular applications, must be a mortar install over a concrete slab.

ESPRIT

STONE FINISH PORCELAIN PAVERS



Esprit offers a soft, luxurious interpretation of natural stone with subtle natural veins and a refined texture that creates an elegant, understated look.



AVAILABLE COLORS



Crema Luna
EP 04 ST - V2

SHAPES & SIZES



23.54 x 23.54 x 3/4



23.54 x 47.16 x 3/4



Spacers are recommended for all porcelain paver installations.
PLEASE NOTE: For vehicular applications, must be a mortar install over a concrete slab.

SPECIAL ORDER

NA.ME

STONE FINISH PORCELAIN PAVERS



Na.Me is the synthesis of the words *natural* and *time*. With Mediterranean and Nordic influences, each unique slab offers interpretations of the natural veins and subtle imperfections of various natural stones.

AVAILABLE COLORS



Bourgogne
NE 12 ST - V2

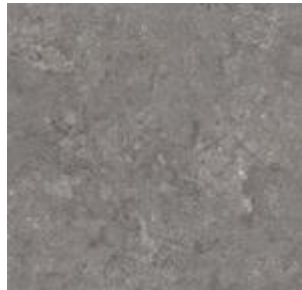

Gris Beige
NE 32 ST - V2

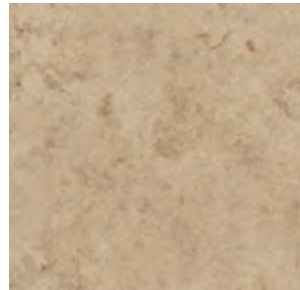

Jura Beige
NE 10 ST - V2

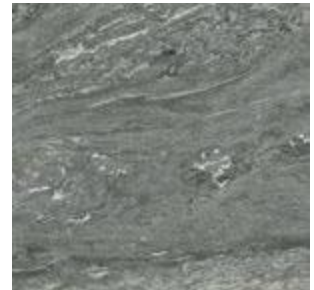

Lumnezia
NE 21 ST - V2

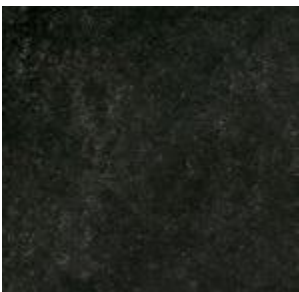

Noir Beige
NE 30 ST - V2



Ocean Gray
NE 13 ST - V2

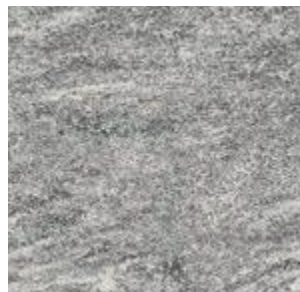

Swiss Gray
NE 20 ST - V2

SHAPES & SIZES

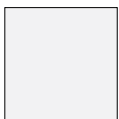

23.54 x 23.54 x 3/4



17.64 x 35.35 x 3/4

UNICO

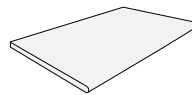

12.99 x 23.54 x 3/4

See page 90 for full product information.



Spacers are recommended for all porcelain paver installations. PLEASE NOTE: For vehicular applications, must be a mortar install over a concrete slab.



QUARZITI 2.0

STONE FINISH PORCELAIN PAVERS



Quarziti 2.0 is an interpretation of stone that incorporates a gentle shading effect to recreate an authentic diversity of natural elements. A variety of modular shapes offer ultimate design flexibility.



AVAILABLE COLORS

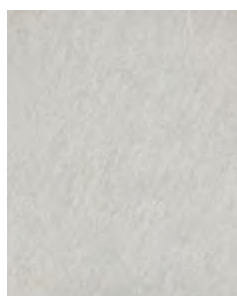

Glacier
QR 01 NAT – V3

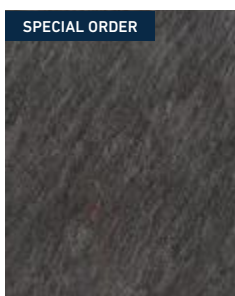

SPECIAL ORDER
Mantle
QR 05 NAT – V2

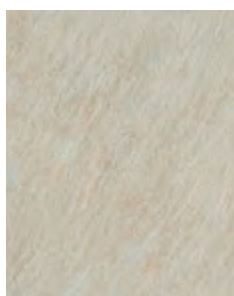

Mountains
QR 02 NAT – V3



River
QR 04 NAT – V3



Waterfall
QR 03 NAT – V3

SHAPES & SIZES

MODULAR
SPECIAL ORDER

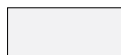

11.73 x 23.54 x 3/4"



17.64 x 35.35 x 3/4"

UNICO

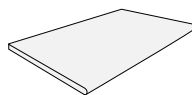

12.99 x 23.54 x 3/4"

See page 90 for full product information.



Spacers are recommended for all porcelain paver installations. PLEASE NOTE: For vehicular applications, must be a mortar install over a concrete slab.

STONES 2.0

STONE FINISH PORCELAIN PAVERS



Stones 2.0 offers the supple texture of groundface stone in large modular shapes ideal for creating stylish contemporary outdoor living spaces.



AVAILABLE COLORS

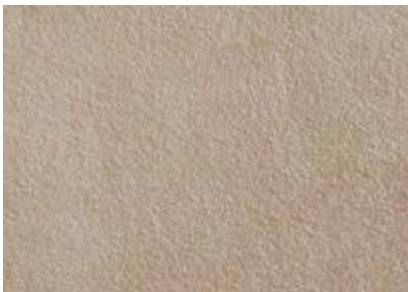

Chambrod
SO 05 ST - V3



Pierre Bleu Sablée
SO 11 ST - V3

SHAPES & SIZES



See page 90 for full product information.



Spacers are recommended for all porcelain paver installations.
PLEASE NOTE: For vehicular applications, must be a mortar install over a concrete slab.

NEW TURIN

STONE FINISH PORCELAIN PAVERS



Turin porcelain pavers closely mimic the subtle textures and muted iridescence of natural unpolished quartz to create stunning contemporary outdoor living spaces and poolscapes.



AVAILABLE COLORS

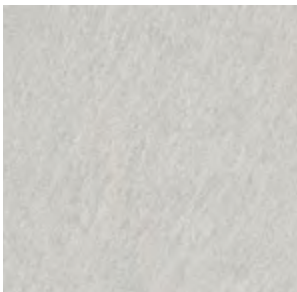

Frost - V3



Canyon - V3



Rapids - V3



Stream - V3

SHAPES & SIZES

SPECIAL ORDER



23.54 x 23.54 x 3/4



Spacers are recommended for all porcelain paver installations. PLEASE NOTE: For vehicular applications, must be a mortar install over a concrete slab.



NEW VERONA

STONE FINISH PORCELAIN PAVERS

The Verona line emulates a variety of natural stones to create distinctive outdoor living designs. Each available color was fashioned to closely mimic the specific natural qualities of a different quarried stone.



AVAILABLE COLORS



Blue Stone – V3



Platinum – V3



Taos – V3



Yukon – V4

SHAPES & SIZES

SPECIAL ORDER



23.54 x 23.54 x 3/4



Spacers are recommended for all porcelain paver installations. PLEASE NOTE: For vehicular applications, must be a mortar install over a concrete slab.

NAU

WOOD FINISH PORCELAIN PAVERS



Nau interprets the character of reclaimed wood on a durable porcelain paver. Available in either squares or planks, Nau creates outdoor living spaces with distinctive urban flair.



AVAILABLE COLORS



Fado
NA 01 RD - V3



Indie
NA 02 RD - V3

SHAPES & SIZES

SPECIAL ORDER

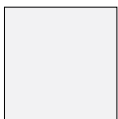

23.54 x 23.54 x 3/4

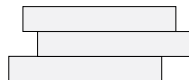

7.80 x 47.17 x 3/4

SPECIAL ORDER



11.73 x 47.17 x 3/4



Spacers are recommended for all porcelain paver installations. PLEASE NOTE: For vehicular applications, must be a mortar install over a concrete slab.

NOON

WOOD FINISH PORCELAIN PAVERS



Warm and bursting with light, Noon is a contemporary expression of the simple life. Setting the scene to enjoy the good things in life.



AVAILABLE COLORS

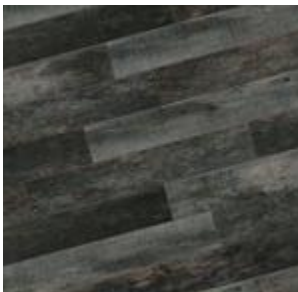

Charcoal
NN 05 ST - V4

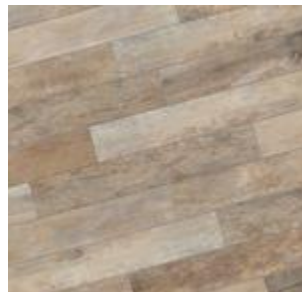

Daylight
NN 01 ST - V4



Ember
NN 02 ST - V4



Honey
NN 03 ST - V4

SHAPES & SIZES

SPECIAL ORDER



23.54 x 23.54 x 3/4

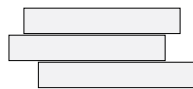

7.64 x 47.17 x 3/4

SPECIAL ORDER

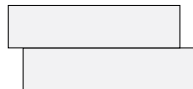

11.73 x 47.17 x 3/4

UNICO

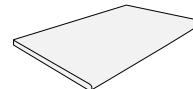

12.99 x 23.54 x 3/4

See page 90 for full product information.



Spacers are recommended for all porcelain paver installations. PLEASE NOTE: For vehicular applications, must be a mortar install over a concrete slab.

SUNDECK

WOOD FINISH PORCELAIN PAVERS



Sundeck is an outdoor interpretation of indoor wood flooring with striations and shading that capture the essence of various wood finishes. Available in either squares or planks for increased design flexibility.



AVAILABLE COLORS

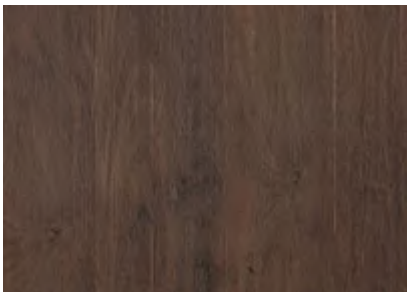

Classic
SD 02 RD - V2

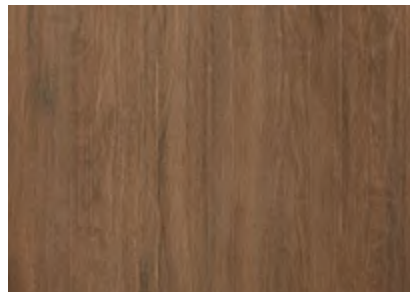

Origin
SD 01 RD - V2

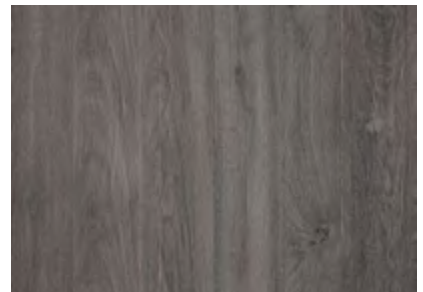

Spirit
SD 03 ST - V4

SHAPES & SIZES

SPECIAL ORDER



23.54 x 23.54 x 3/4



11.73 x 47.17 x 3/4

UNICO

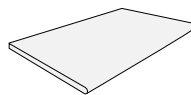

12.99 x 23.54 x 3/4

See page 90 for full product information.



Spacers are recommended for all porcelain paver installations. PLEASE NOTE: For vehicular applications, must be a mortar install over a concrete slab.

UNICO

STEPS / COPING



Two installation needs, a single solution. This versatile porcelain unit is processed on both sides to give you maximum flexibility and design freedom.

Unico can be used as a step and as a coping for swimming pools. With a rounded, bullnose edge or straight edge, this uniquely functional border piece looks great from every angle.



SIZE

12.99 x 23.54 x 3/4
Double sided special trim



ROUNDED EDGE



STRAIGHT EDGE

AVAILABLE COLORS *STONE FINISH*



Island
AD 02 NAT - V3



Shore*
AD 01 NAT - V3



Vulcan
AD 05 NAT - V3



Bourgogne*
NE 12 ST - V2



Gris Beige*
NE 32 ST - V2

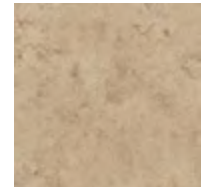

Jura Beige*
NE 10 ST - V2

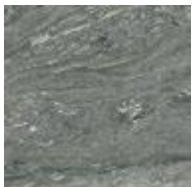

Lumnezia*
NE 21 ST - V2

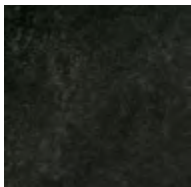

Noir Beige*
NE 30 ST - V2



Ocean Gray*
NE 13 ST - V2



Swiss Gray*
NE 20 ST - V2

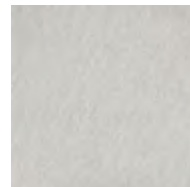

Glacier
QR 01 NAT - V3

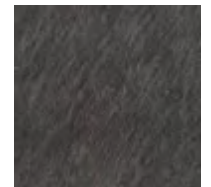

Mantle*
QR 05 NAT - V2



Mountains
QR 02 NAT - V3

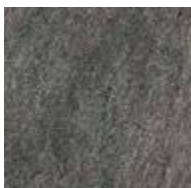

River
QR 04 NAT - V3



Waterfall
QR 03 NAT - V3



Chambrod
SO 05 ST - V3



Pierre Bleue Sablée
SO 11 ST - V3

*SPECIAL ORDER



AVAILABLE COLORS *WOOD FINISH*



Charcoal
NN 05 ST - V4

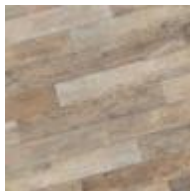

Daylight
NN 01 ST - V4

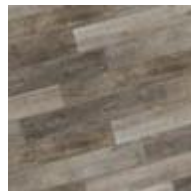

Ember
NN 02 ST - V4

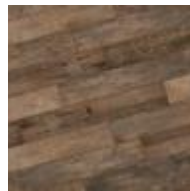

Honey
NN 03 ST - V4



Classic
SD 02 RD - V2

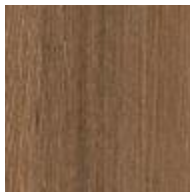

Origin
SD 01 RD - V2

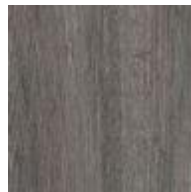

Spirit
SD 02 ST - V4

NEW PORCELAIN VENEER BY MIRAGE®

Create stylish, harmonious outdoor and indoor living environments with Mirage Porcelain Veneer. Crafted in Italy, these veneers are designed to coordinate with various Belgard® porcelain pavers.



AVAILABLE COLORS

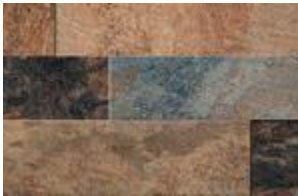

African Stone



Daylight



Ember



Glacier

SPECIAL ORDER COLORS



Charcoal



Island



River



Waterfall

SHAPES & SIZES

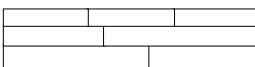

4.06 x 17.52



WALLS

98

Castlemanor®

100

Diamond® 9D

NEW

101

Diamond® 9D
2.0 FSW

102

Diamond Pro®

103

Diamond Pro® PS

104

Diamond Pro
Stone Cut®

108

Ashlar Tandem™

110

Tandem®
Column Kit

112

Tandem®
Modular Grid

113

U Start Base Block®

114

Weston Stone™

Weston Stone

LEGEND



STEPS



WALLS



FIRE PITS



KITCHENS



COLUMNS

WALLS

SCULPTED STANDARD or PRO

Whatever the building requirement, Belgard® wall systems are designed to work in harmony with your landscape. From functional retaining walls to fashionable outdoor living areas, you decide the application.

WE'LL PAVE THE WAY



Ashlar Tandem Wall

FREESTANDING OR RETAINING

Knowing the difference between retaining and freestanding walls can have a positive impact on your project and lead to a more enjoyable outdoor space.

Freestanding walls allow you to divide your outdoor living space into different areas. They provide visual interest and can make even the largest yard feel more intimate. Freestanding walls easily incorporate with other features like fireplaces or outdoor kitchens to provide a cohesive look.

Retaining walls can have multiple purposes. Some help to increase usable space, whether that be a flower bed or added yard space, while other retaining walls help to prevent erosion. Either application is made possible by a wall system that holds back soil and properly manages drainage. Larger walls also utilize soil reinforcement for added strength and long-term stability.



PICTURED: CASTLEMANOR



ASHLAR TANDEM & TANDEM COLUMN KIT

ACCESSORIES

The details complete the design. Belgard offers caps, columns and other accessories to complement any hardscape design. Mix textures to add a modern look to a rough-hewn wall-face. Include a cap in a complementing color to add visual interest. The possibilities are endless!

Consult a Belgard Certified contractor for information on all of our wall products and to receive project design assistance through Belgard Design Studio.



HOW TO SHOP WALLS

FACE-STYLES

Outdoor areas of any size or shape can be transformed with Belgard wall products. The shapes and textures of our wall systems blend with the environment to create attractive and functional landscape wall features.



STRAIGHT
CRISP, CLEAN LINES



SMOOTH
*COBBLED, RUSTIC
AND ANTIQUED*



STONE CUT
*ROUNDED AND
ROUGH-HEWN*



STONE TEXTURED
*DISTINCTIVE LOOK
OF HAND WORKED
STONE*

CASTLEMANOR®

FREESTANDING / RETAINING WALLS



Castlemanor wall system is a versatile, multi-piece wall system with multi-dimensional character. The variations in unit dimensions allow for the greatest degree of random layout.



AVAILABLE COLORS



Amaretto



Harvest Blend



Napoli



Slate

Swatches represent product color only, not surface texture, dimensions or shape.

SHAPES & SIZES

Wall Units



6 x 6 / 4 x 10



6 x 12 / 10 x 10



6 x 16 / 14 x 10

Pins



6" L x 3/8" D
approx. 3.5 pins
per sq. ft.

Cap



3 x 12 x 10



DIAMOND® 9D

RETAINING WALLS



The rough-hewn distressed look and easy installation system have made Diamond 9D a favorite for residential wall projects. The system is topped with a coordinating cap unit.



AVAILABLE COLORS



Amaretto



Harvest Blend



Napoli



Slate

SHAPES & SIZES

Stone Cut



6 x 17 $\frac{3}{4}$ x 9

Corner/Column Unit



6 x 18 x 6

Cap



3 x 17/12 x 10 $\frac{1}{2}$



U Start Base Block®
3 $\frac{1}{2}$ x 18 $\frac{1}{2}$ x 12*
(Sold Separately)

Recommended for use with all available wall block units. See page 113 for full product information.

*Note: U Start Base Block actual coverage length is 16 $\frac{1}{16}$ "

Wall Innovations By



NEW DIAMOND® 9D 2.0 FREESTANDING WALLS

With a rough-hewn face and multiple sizes, Diamond 9D 2.0 offers the look of a charming hand-stacked wall and can be used to create planters, raised patios, columns and more.



AVAILABLE COLORS



Amaretto



Harvest Blend



Napoli



Slate

SHAPES & SIZES

Small Block



6 x 6 x 5

Medium Block



6 x 12 x 5

Large Block



6 x 18 x 5

Column/Corner Unit



6 x 16 x 5

XL™ Cap



Front: 3 x 18 / 12 x 13



U Start Base Block®
3½ x 18½ x 12*
(Sold Separately)

Recommended for use with all available wall block units. See page 113 for full product information.

*Note: U Start Base Block actual coverage length is 16⅞"

Wall Innovations By



DIAMOND PRO[®]

RETAINING WALLS



Available in straight face and beveled face, the time-tested strength of Diamond Pro retaining wall systems makes it the contractors' choice for large-scale projects.



AVAILABLE COLORS



Harvest Blend



Napoli



Pebble



Slate

Colors available in both beveled and straight face styles.

SHAPES & SIZES

Straight Face



8 x 18 x 12

Beveled Face



8 x 18 x 12

Corner/Column Unit



8 x 18 x 8

Cap Unit



4 x 17 / 12 x 10

Wall Innovations By



DIAMOND PRO[®] PS

RETAINING WALLS



Architects and homeowners alike choose the Diamond Pro PS retaining wall system to create flexible, cost effective solutions for a broad range of large retaining wall projects. Diamond Pro PS utilizes a pin system as a location device which adds to the ease of installation.



AVAILABLE COLORS



Harvest Blend



Napoli



Pebble



Slate

SHAPES & SIZES

Straight II Face



8 x 18 x 12

Corner/Column Unit



8 x 18 x 8

Cap Unit



4 x 17 / 12 x 10

Anchor[™] Fiberglass Pins



5" L x 0.5" D
2 pins per sq. ft.

Wall Innovations By



DIAMOND PRO STONE CUT[®]

RETAINING WALLS

Renowned for its rough-hewn face and earthen tones, the Diamond Pro Stone Cut retaining wall system imparts a rich, faceted appearance. It is the ideal choice for large scale wall projects.



AVAILABLE COLORS



Harvest Blend



Napoli



Pebble



Slate

SHAPES & SIZES

Large Unit



8 x 18 x 12

Small & Medium Units



8 x 7 x 12



8 x 11 x 12

Corner/Column Unit



8 x 18 x 8

Cap



4 x 17 / 12 x 10

Wall Innovations By







TANDEM® WALL

The Tandem family of products is a revolutionary platform that showcases the stone-like aesthetic that homeowners prefer while offering job site efficiencies contractors need. A complete system, with a Column Kit and Modular Grid, Tandem provides versatility to complement any outdoor living space.





WALLS

The **Tandem® Wall** system designed by Belgard® is an innovative, versatile system that can be used to create attractive, curved or straight retaining and freestanding landscape walls. Great for use in a wide range of residential and light commercial hardscape projects.

COLUMNS

Building columns is easy with the Tandem system. Add a finishing touch to a wall, create a grand entry at the end of a driveway or dress-up an existing deck post with a stone-faced column. Ask your Belgard Representative about our **Tandem® Column Kit** (page 110) with Column Grids, Connectors and Veneer Units in one convenient package.

MODULAR GRID

Tandem® Modular Grid (page 112) is a revolutionary system that makes it easy to construct outdoor living elements. Use steel Column Grids and heavy-duty connectors to construct virtually any structure up to 7 ft tall including privacy walls, outdoor benches, kitchens and much more.

HOW IT WORKS

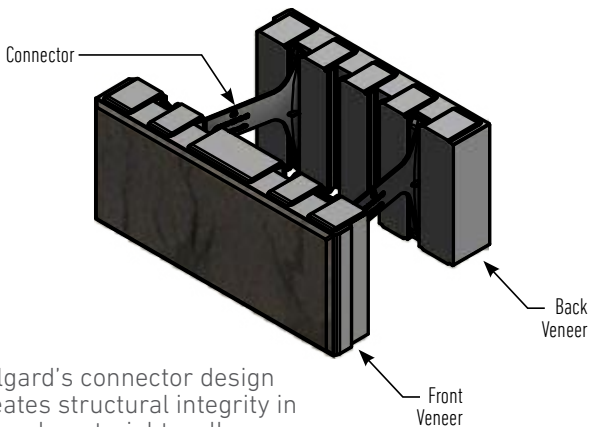

Belgard's connector design creates structural integrity in curved or straight walls.



BENEFITS BY THE NUMBERS:

- Meets additional ASTM standards (C-1372 & C-1262)
- Freestanding walls up to 28"
- Exceeds 5,000 PSI compressive strength concrete
- Engineered 90° corners
- Gravity walls up to 3 ft
- Reinforced walls up to 7 ft

ASHLAR TANDEM™

FREESTANDING / RETAINING WALLS



A wall system that creates a unique modular look and can be used in many ways: retaining walls, pillars, double-sided walls, benches and steps. This revolutionary wall replicates the look of natural stone.

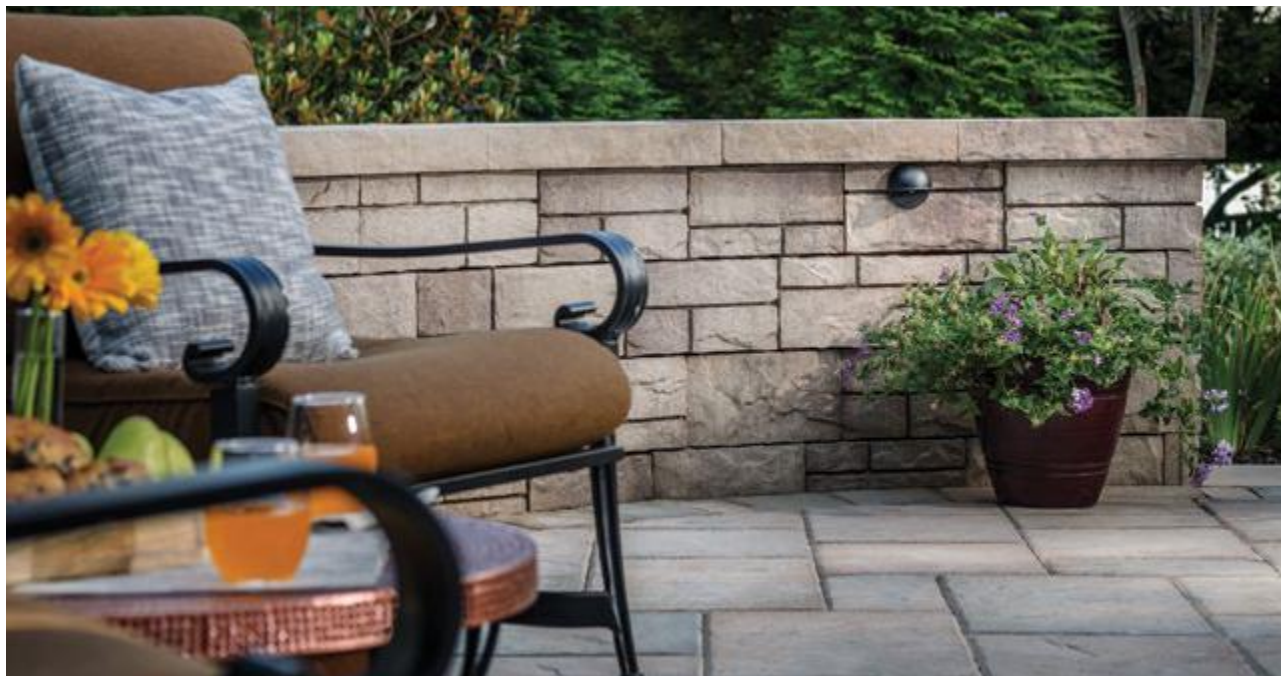

AVAILABLE COLORS



Avondale



U Start Base Block®
 $3\frac{1}{2} \times 18\frac{1}{2} \times 12^*$
 (Sold Separately)

Recommended for use with all available wall block units. See page 113 for full product information.

**Note: U Start Base Block actual coverage length is $16\frac{1}{16}$ "*

SHAPES & SIZES

Ashlar Tandem Unit 1



$7 \times 13\frac{3}{16} \times 2\frac{5}{8}$

Ashlar Tandem Unit 2



$7 \times 15\frac{1}{16} \times 2\frac{5}{8}$

Ashlar Tandem Unit 3



$7 \times 18\frac{1}{16} \times 2\frac{5}{8}$

Ashlar Tandem Unit 4&5



$7 \times 13\frac{3}{16} \times 2\frac{5}{8}$
 $7 \times 15\frac{1}{16} \times 2\frac{5}{8}$

Tandem® Wall Cap



$3\frac{1}{4} \times 24 \times 15$

8" Connecting Member

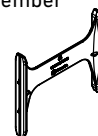

Ashlar Units 1-5 come mixed on one pallet.



TANDEM® COLUMN KIT



Tandem Column Kit is an innovative, versatile system that can be used to create attractive, easy to install and durable columns. Great for use in residential and light commercial hardscape projects.



AVAILABLE COLORS



Avondale



See the installation video at [Beldgard.com/Tandem](http://Belgard.com/Tandem)

SHAPES & SIZES

Tandem Column Kit includes 1 Column Grid, 1 Bag of Connectors & Tandem Units.



Ashlar Tandem™
Unit

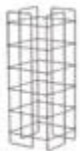

Column Grid
Height 42"



Connector



Tandem Wall Cap
3¼ x 24 x 24
(Sold Separately)



U Start Base Block®
3½ x 18½ x 12*
(Sold Separately)

Recommended for use with all available wall block units. See page 113 for full product information.

*Note: U Start Base Block actual coverage length is 16¼"



1 Start with Column Grid



2 Use connector to attach Ashlar Tandem Veneers to grid



3 Repeat step 2 and fill with 3/4" crushed rock until column is complete



TANDEM® MODULAR GRID



Construct virtually any design up to 7' tall by simply attaching the grids to a wooden structure and connecting the veneers. Build an outdoor kitchen, skirt a deck, hide utilities, construct seat walls... the possibilities are endless.



1 Build your wooden frame



2 Attach your modular grid



3 Attach Tandem Veneer with Connector



4 Finish with Tandem Cap Unit

AVAILABLE COLORS



Avondale

ASHLAR TANDEM™ VENEER UNITS**

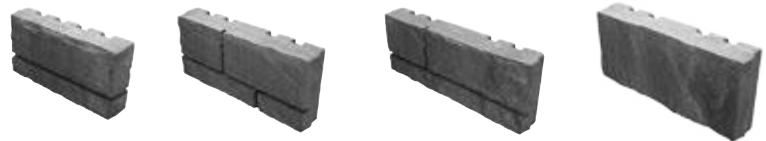

CONNECTOR



MODULAR GRID

Vertical or Horizontal Application



U START BASE BLOCK®



3½ x 18½ x 12*
(Sold Separately)

*Note: U Start Base Block actual coverage length is 16⅞"

**Ashlar Tandem Veneer units available in three sizes. Units only available in 7" height. See page 108 for full product information.

U START BASE BLOCK®



One of Belgard's latest innovations, U Start Base Block is a universal base course for landscaping walls that promotes cost savings and installation time efficiency.

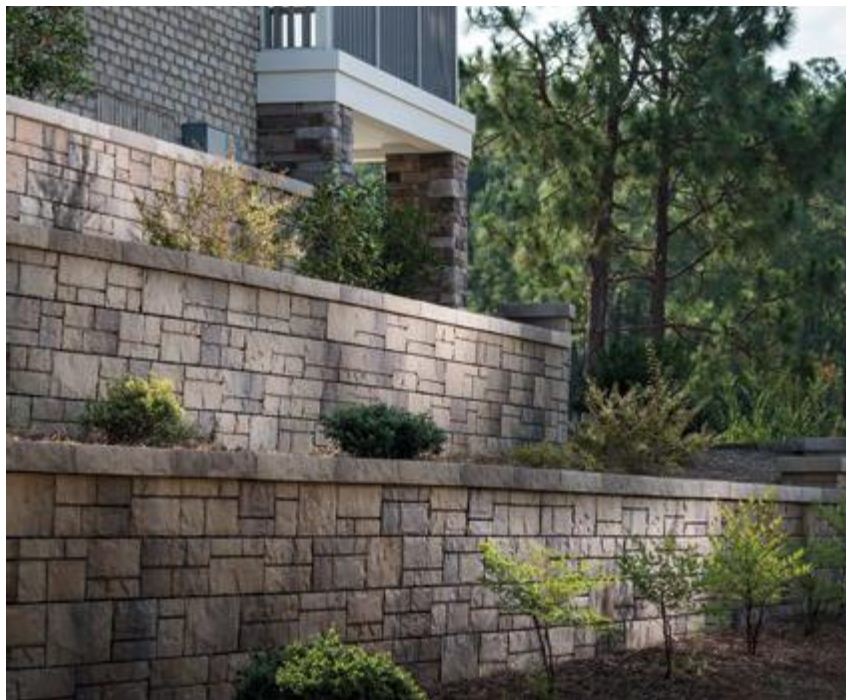

1
Prep Site

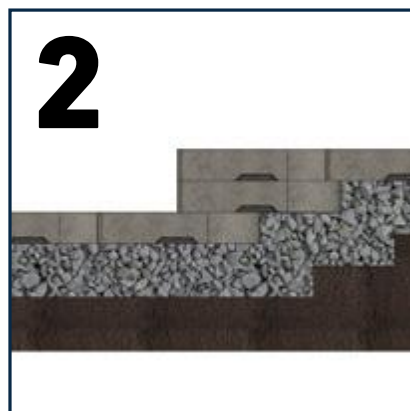

2
Install Base Course

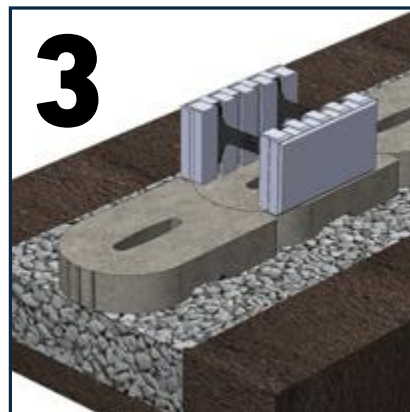

3
Install the Wall

SHAPES & SIZES

Recommended for use with all available wall block units.



Base Block
3½ x 18½ x 12*
*Note: U Start Base Block actual
coverage length is 16¼"



Base Block with Ashlar Tandem™ Wall

WESTON STONE™

FREESTANDING / RETAINING WALLS



The flexibility of Weston Stone is unmatched. With the look of natural tumbled stone, this double-sided wall is ideal for garden walls, pillars, outdoor kitchens, planters and fire features.



AVAILABLE COLORS



Amaretto



Harvest Blend



Napoli



Slate

SHAPES & SIZES

3-Piece



4 x 8 / 5 x 8



4 x 12 / 9 x 8



4 x 16 / 13 x 8

Universal



4 x 12 x 8



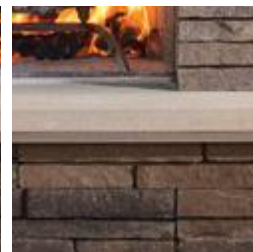

FIRE FEATURES

FIREPLACES OUTDOOR KITCHENS FIRE PITS

Outdoor focal points don't have to be a hassle. Our pre-assembled modular fireplaces and outdoor kitchens take the guesswork out of assembly and our fire pit kits make relaxation simple and installation easy. You cozy up.

WE'LL PAVE THE WAY



*Bristol Series Fireplace, Hearth & Wood Boxes
Opposite: Bordeaux Series Fireplace & Wood Boxes*

OUTDOOR FIRE FEATURES AND KITCHENS

Browse our outdoor kitchen collections and fireplace kits to find the right centerpiece for your al fresco experience. Our line of pre-assembled modular Elements™ not only carry our standard warranty, but also can be installed within hours to any project.



SPECIAL ORDER BRISTOL™ SERIES

A beautiful combination of tumbled block with Arbel® and Urbana® accents, Bristol's rustic look blends well with virtually any landscape.



SPECIAL ORDER BRIGHTON™ SERIES

Featuring the same 36" firebox as the Bristol Series, plus a built-in hearth and metal accent, Brighton is a beautiful option.



BORDEAUX™ SERIES

A timeless stackstone design that allows the fireplace, the grill island, or the brick oven to become the focal point of your outdoor space.



Shop Belgard Outdoor Kitchen and Fire Features at [Belgard.com/Elements](https://www.belgard.com/Elements)

BRICK OVENS

Inspired by traditional oven designs first used over four thousand years ago. The secret is our authentic, low-height Neapolitan dome design. The design creates high, even temperatures for balanced cooking and genuine wood-fired taste.

Available in Bordeaux™ and Bristol™ Series.

NOTE: All our Fireplaces, Brick Ovens, and Fire Pits come standard as wood-burning units. However, our fireplaces and fire pits can be retro-fitted for gas burning log sets and burners. Our brick ovens are wood burning units only. Please contact us for more details 877-235-4273. Also, be sure to check with your local municipality for any codes that may affect your installation.



Bristol™ Series Brick Oven



WESTON STONE™ FIRE PIT KIT

Belgard's Weston Stone™ Universal Fire Pit Kit installs quickly and offers the clean and contemporary look of tumbled stone. Available in four popular color blends developed to complement most Belgard paving stone and retaining wall types. Also available in square kits.

BORDEAUX GRILL ISLAND

Featuring a Napoleon gas grill and stainless door set, Belgard's Bordeaux Grill Island will have you grilling in no time!



BORDEAUX™ SERIES

FIREPLACE

2'7"D x 4'3"W x 7'8"H

Our Bordeaux Series features a Lamina Stone for the body, and eye catching Cordova Stone Coping and Accents in either Midnight or Buff colors.



Fireplace Wood Boxes
2'1¼"D x 3'3"W x 3'1"H
per box
Sold as a pair.



Grill Island
2'6"D x 5'11"W x 3'5"H
Includes Napoleon Grill and Door Set. Grill is available in propane or natural gas. Must be specified when placing order.



Brick Oven
42½"D x 53¼"W x 92"H

SPECIAL ORDER BRISTOL™ SERIES FIREPLACE

3'D x 5'W x 9'3"H

Our Bristol Series features Weston Stone for the body, with accents of Urbana and Mega-Arbel. It's available in either brown or gray tones.



Fireplace Wood Boxes
2'4"D x 3'W x 3'3"H
per box
Sold as a pair.



Fireplace Hearth
2'D x 5'W x 11"H



Brick Oven
4'D x 4'W x 8'5"H



Grill Island
3'D x 6'4"W x 4'4"H
Includes Napoleon Grill and Door Set. Grill is available in propane or natural gas. Must be specified when placing order

SPECIAL ORDER BRISTOL™ SERIES FIREPLACE

3'4"D x 4'4"W x 8'4"H

Our Brighton Series features Weston Stone for the body, with Urbana Accents. It's available in either brown or gray tones. Includes wrought metal accent.



Fireplace Wood Boxes
2'4"D x 2'8"W x 2'11"H
per box
Sold as a pair.



Fireplace
3'4"D x 4'8"W x 8'4"H



NEW WESTON STONE™ KITS

Our Weston Stone Kits have a cleaner, more contemporary look, as opposed to more textured products. Kits are available in popular color blends developed to complement Belgard paving stone and retaining wall types.



AVAILABLE COLORS



Amaretto



Harvest Blend



Napoli



Slate



Grill Island
3'2"D x 5'11"W x 3'4"H



Linear Fireplace
3'2"D x 8'2"W x 40"H



Linear Fire Pit
3'2"D x 8'2"W x 16"H



WESTON STONE™ FIRE PIT KIT



For those who prefer a cleaner, more contemporary look, Belgard's Weston Stone Fire Pit Kit offers a pleasing visual alternative to some of our more textured products.



AVAILABLE COLORS



Amaretto



Harvest Blend



Napoli



Slate

SHAPES & SIZES

Circle Fire Pit



4 x 8 x 8



4 x 12 x 8

Circle Insert

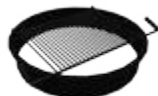

55" Outside
40" Inside
16" Tall

Square Fire Pit



4 x 12 x 8

Square Insert



44" Outside
28" Inside
16" Tall

*Metal insert, grate
& glue are included in
Fire Pit Kit*





COPING

130
Bullnose

132
Fountainhead

134
Oceanside

136
Seville

ACCESSORIES

COPING

Whether chiseled and brawny or smooth and precise, it's the finishing touches that make the final statement. You craft the message.

**WE'LL PAVE
THE WAY**

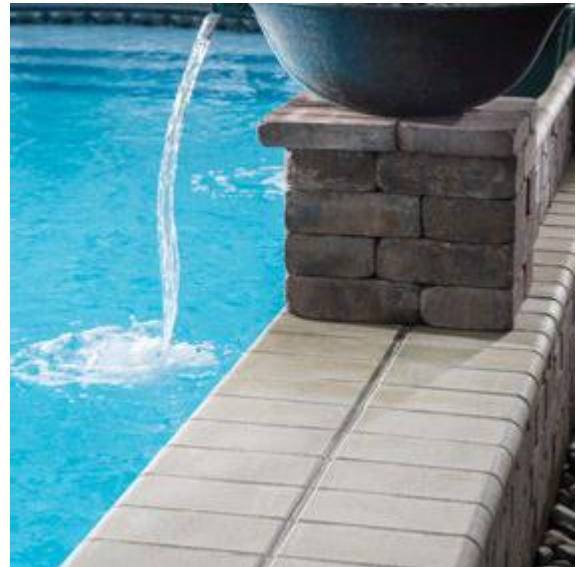

Pictured: Bullnose Coping

BULLNOSE

COPING



Bullnose coping features a smooth surface and can be used as a finishing accent for an array of outdoor living features, including pools, steps, seat walls, outdoor kitchen counters, foot ledges and more.

AVAILABLE COLORS



Amaretto



Camel



Charcoal



Chestnut



Cream



Harvest Blend



Malt



Napoli

Also available in Titanium, refer to page 10 for color sample.

SHAPES & SIZES

Bullnose Coping



4 x 9 x 2 3/8



FOUNTAINHEAD

COPING



Fountainhead coping allows your beautiful patio to integrate seamlessly with a pool. The variety of color options allow for a custom look complementing the different paver options that are available.

AVAILABLE COLORS



Amaretto



Camel



Charcoal



Chestnut



Cream



Harvest Blend



Malt



Napoli

Also available in Titanium, refer to page 10 for color sample.

SHAPES & SIZES

Fountainhead Coping



4 x 9 x 5½
4" Drop



OCEANSIDE

COPING



Oceanside coping combines coquina and oyster shells with a truly durable product for a level of natural beauty few pavers can match. Available in both Bullnose and Seville Coping products.



AVAILABLE COLORS



Camel



Cream



Gray



Malt



White

SHAPES & SIZES See page 68 for matching paver products.

Bullnose Coping



4 x 9 x 2 $\frac{3}{8}$

Seville Coping



4 x 9 x 4
2 $\frac{1}{2}$ Drop



SEVILLE

COPING



Seville coping allows your beautiful patio to integrate seamlessly with a pool. Seville is also versatile enough to function as an edge restraint for all of our premium paver products.

AVAILABLE COLORS



Amaretto



Camel



Charcoal



Chestnut



Cream



Harvest Blend



Malt



Napoli

Also available in Titanium, refer to page 10 for color sample.

SHAPES & SIZES

Seville Coping



4 x 9 x 4
2½ Drop





PAVER CARE

PROTECT YOUR INVESTMENT

Belgard Products are designed to last for generations. Many homeowners choose to further protect and beautify their investment by applying a protective sealer. Adding a sealer can enhance the beauty of a project by highlighting the color and texture of the surface. It will also offer protection from stains like oil, grease or other accidental leaks.

Techniseal Protector for Concrete Pavers (Top-Bottom): Natural Look Matte Finish, Clear Look Semi-Gloss Finish, Color Boost Matte Finish, Wet Look Gloss Finish

THE ULTIMATE PROTECTION SYSTEM

Techniseal's 3-step treatment system guarantees the best results. Remove stains with a specially formulated Stain Remover, prepare the surface with Paver Prep, then apply a Protector that delivers the look you want.

1 PREP

STAIN REMOVERS



2 CLEAN

CLEANERS

- Dislodges efflorescence and ground-in dirt
- Prepares pavers prior to protector application
- Brightens paver color



3 PROTECT



SAME FINISHES, HIGHER STANDARDS

Our versatile, new sealers have been formulated for easier product selection and application.



NULOOK® TINTED PROTECTOR

- Colors pavers
- Translucent
- Water-based stain guard

DRIBOND™

CHANGING THE WAY YOU OVERLAY

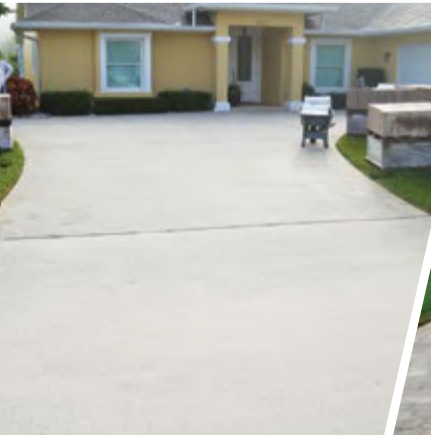

BEFORE



AFTER

No More Concrete Removal!

With DriBond™, there is no need to remove the existing concrete substrate, which is a costly and time-consuming process. DriBond™ can be installed quickly and easily over most sound concrete surfaces.

- Ideal for thin paver overlays
- Dry application
- No mixing - ready to use
- Reduces installation time

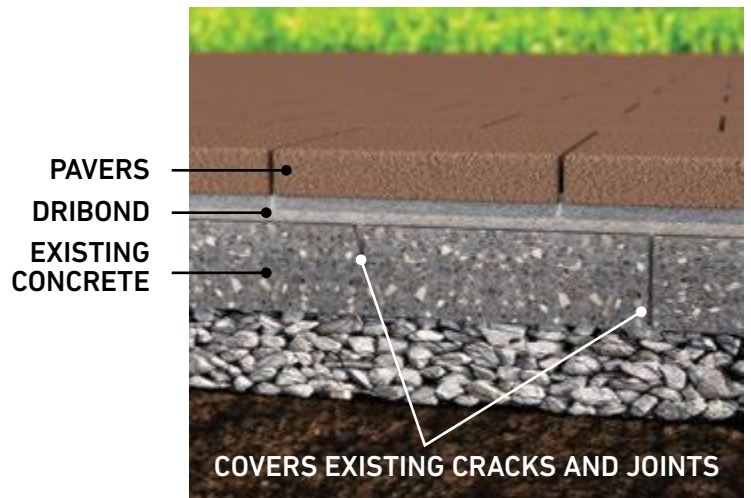

NO MESS. NO WASTE.



8 minutes
SET TIME

Easy to use

Yields
600
feet per can

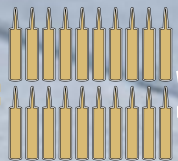
1 =  **20**

STRUCTUREBOND™ IS AN INNOVATIVE SUPER-STRENGTH FOAM ADHESIVE THAT BONDS A WIDE RANGE OF CONSTRUCTION MATERIALS.

Made from high-quality modified polyurethanes, StructureBond's adhesive strength is unmatched among all types of polyurethane adhesives.

StructureBond's Gun allows for a precise adhesive delivery with a single pull of the trigger. No pumping, cutting or puncturing of cartridge nozzles.

VISIT TECHNISEAL.COM FOR MORE DETAILS.



1 PREP

EZ BASE® PANEL BASE SYSTEM



- Saves up to 8 inches of excavation
- Each panel replaces up to 250 lbs of base aggregates
- Ideal for porcelain tile installation

PAVER EDGING

PREVENTS MOVEMENT & DAMAGE TO PAVER INSTALLATIONS



RIGID

8-FT SECTIONS

COIL

40-FT COIL

2 SET



STRUCTURE BOND™

FOAM ADHESIVE

- Application gun also included



DRIBOND™

DRY MUDSET

- Applied directly to existing concrete slab
- Ideal for thin paver overlays installation



BORDERBOND™

FORTIFIER FOR BORDER PAVERS

- No Mixing required
- Enhances the strength of DRiBond

3 SAND



HP NEXTGEL™

JOINTING SAND

- High-performance formula
- For joints up to 4"
- Haze and dust free
- Super fast wetting
- Rapid set
- Prevents erosion and weeds

SELECTING A CONTRACTOR



A hardscape project is an important investment in your home and selecting the right contractor is a critical decision. Don't be afraid to ask a lot of questions. It's important that you get to know your contractor so that you can work together as a team to create your ideal outdoor living space.

WHAT TO ASK

Are you certified?

Inquire about specialized certifications and training from organizations like the Interlocking Concrete Paver Institute (ICPI).

All Belgard® Contractors are required to have at least one team member who is ICPI certified and must meet annual requirements to maintain the company's status.

Are you insured?

It's important to hire a contractor who can provide proof of insurance and is able to guarantee their work for a period of at least three years after the installation.

Can I get a reference?

Ask for customer references and to see photos of past projects, both for design ideas and to get a sense of the contractor's level of creativity, expertise and work ethic. Ask for an address or two and check out the workmanship up close, with the homeowner's permission of course.

What isn't covered in your estimate?

Determine upfront which aspects of the project the contractor can handle. Will their team manage landscaping, plumbing, irrigation and lighting or will you be expected to handle this separately?

What's the schedule?

Be sure to get a complete understanding of payment terms, estimated start date and turn-around time.

CHECKLIST FOR CONTRACTOR:

- | | |
|--|---|
| <input type="checkbox"/> Industry Certification (ICPI, NCMA, SRW) | <input type="checkbox"/> Work Schedule |
| <input type="checkbox"/> Proof of Insurance | <input type="checkbox"/> Price Estimate |
| <input type="checkbox"/> Workmanship Guarantee (1-3 year minimum) | <input type="checkbox"/> Scope of Work/Contract |
| <input type="checkbox"/> Business License/ Contractor's license (where applicable) | <input type="checkbox"/> Referrals |



INSTALL WITH A BELGARD PREFERRED CONTRACTOR

Our network of Belgard Authorized Contractors are ICPI* trained to deliver superior craftsmanship. **Find a contractor or dealer: [Belgard.com/find-contractor](https://www.belgard.com/find-contractor)**

DREAMS ON DEMAND

Step into your dream backyard before construction begins
with Belgard Design Studio



Belgard is your resource for outdoor living inspiration, planning and installation. From charming walkways and welcoming patios to gourmet outdoor kitchens – the possibilities are endless. Let us help you visualize a new outdoor space using virtual reality.

**REVIEW SAMPLE CONTENT, THEN REQUEST A CUSTOM DESIGN FOR YOUR HOME!
VISIT [BELGARD.COM/VR](https://www.belgard.com/vr)**

YOUR PROJECT STARTS HERE

Ready to take the next step?
Belgard provides tools to easily
kick off your next project



BELGARD® WILL IMPROVE THE BEAUTY AND VALUE OF YOUR HOME.

But like any construction project, it's necessary to have as much information as possible before you begin the process. With that in mind, we created a project planning guide dedicated to helping you make the best decisions and understand what to expect before you get started with your project.

GET YOUR PROJECT PLANNING GUIDE AT BELGARD.COM/PLANNER

PROJECT CONSIDERATIONS

- 1 The general project should be conducted in phases, which include: demolition, site preparation, base material installation, bedding sand installation, hardscape installation, polymeric sand installation, additional paver cleaning and sealing.
- 2 The timeline for your hardscaping project depends on several factors including the **size and scale** of the project, **permits needed** (which vary by municipality), and the acceptance of any community organizations, such as homeowner associations or architectural review boards.
- 3 All outdoor projects are subject to **weather conditions** so there could always be delays.
- 4 Spring and summer are the busiest periods for contractors, so **start your planning during the winter months** or consider scheduling your project in slower periods.
- 5 **Confirm all the work you'd like done is contracted and scheduled up front.** Adding additional features will delay the schedule and add to the total cost.
- 6 Check with your contractor to ensure that all items being installed are readily available or match your timeline.
- 7 Be sure to **discuss with your neighbors** any construction phases that might be disruptive so that you can communicate that information to them as needed.
- 8 If you have a large project and would like to phase out construction over time, be sure to **plan the entire design** before you get started so that you can plan for any electrical, plumbing, drainage or landscaping needs.
- 9 Consider building your backyard before any projects in the front yard to avoid damaging your front yard.
- 10 When your project is finished, **walk through it with your contractor** to ensure the quality of the install, and **ensure you have receipts for materials / labor** and have registered your warranty.
- 11 Always take into consideration the next step of the project: What does the landscaping look like? Do you need to schedule the contractor to seal the pavers? Plan ahead to make sure you finalize your project and can enjoy it for years to come.



TIMELINE -

Planning the project

PHASE 1: 4-6 weeks

- 1 Consider how you will use the space and your budget
- 2 Examine styles and colors for your house or landscape
- 3 Get inspiration online
- 4 Research approval requirements from municipality or HOA
- 5 Set a budget

Installation

PHASE 3: 2-12 weeks

- 1 Time of the installation will depend on the scope of the project
- 2 Check with the contractor to ensure the materials ordered have arrived and are accurate
- 3 Connect with your contractor to ensure it is project



MAKE YOUR DREAMS A REALITY

with Belgard Preferred Payment



With the Belgard® Preferred Payment program, you can complete your outdoor project in just a few weeks, instead of phasing it out over several months or years.

Available only through **Belgard Contractors or Dealers**, Preferred Payment offers same-as-cash financing that allows you to start your project immediately.

There are often construction economies that can be achieved by doing the entire project at once, **which could save you both money and time.**

Plus, you get to start enjoying your dream outdoor living space much sooner!

**TO LEARN MORE,
VISIT BELGARD.COM/BPP**

BENEFITS OF BELGARD FINANCING INCLUDE:

- No payments or interest on approved credit
- Quick, easy and safe toll-free loan-by-phone application process
- No paperwork
- A credit decision in about 10 minutes
- No application fees, no closing costs and no prepayment penalties

VISUALIZE YOUR PROJECT

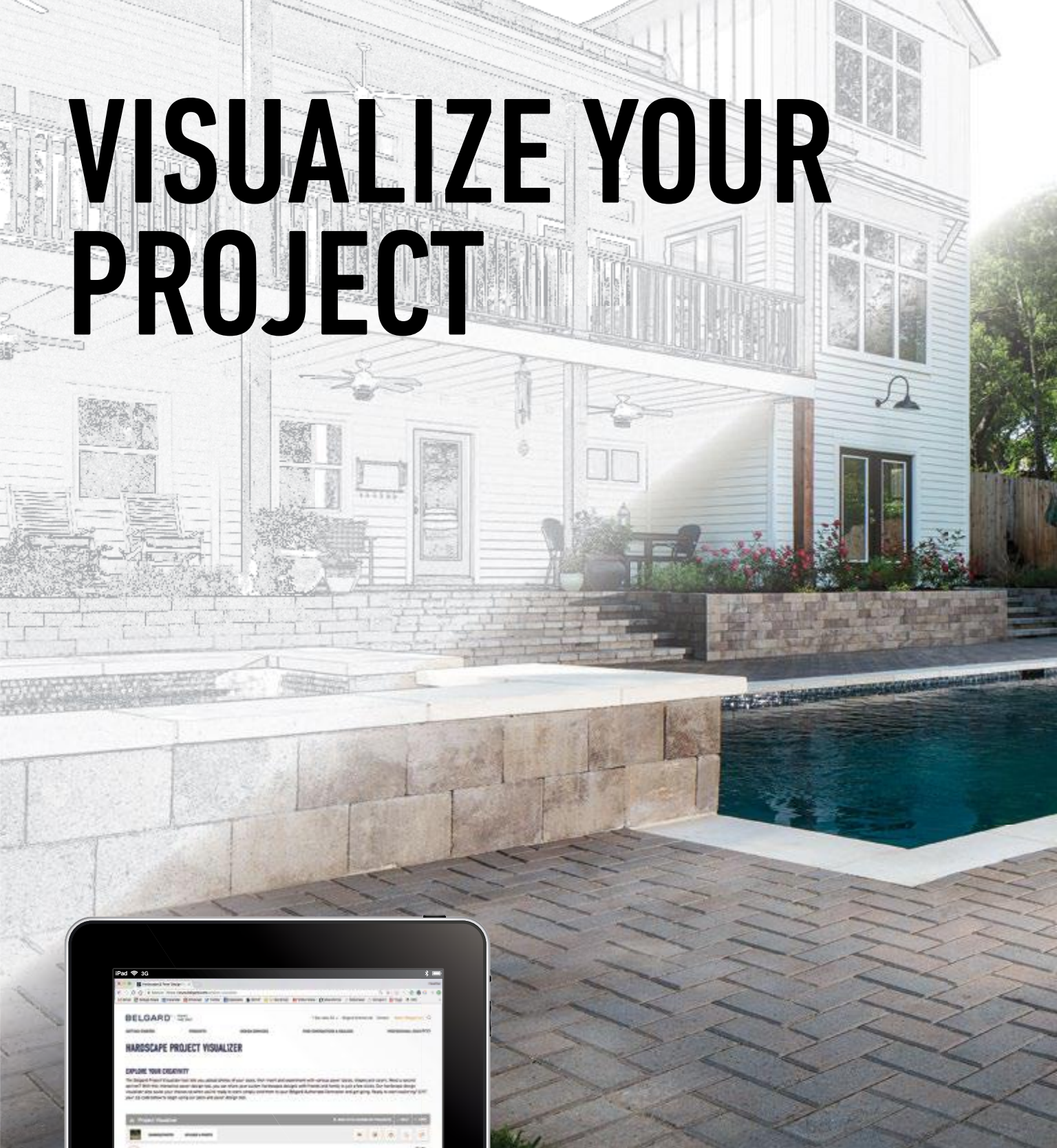

Belgard's online Project Visualizer allows you to be your own hardscape designer. Choose from our image library or upload your own photo to experiment with paver styles and colors and explore an infinite number of design possibilities.

**READY TO "VISUALIZE" YOUR BACKYARD MAKEOVER?
VISIT [BELGARD.COM/SEEIT](https://www.belgard.com/seeit)**

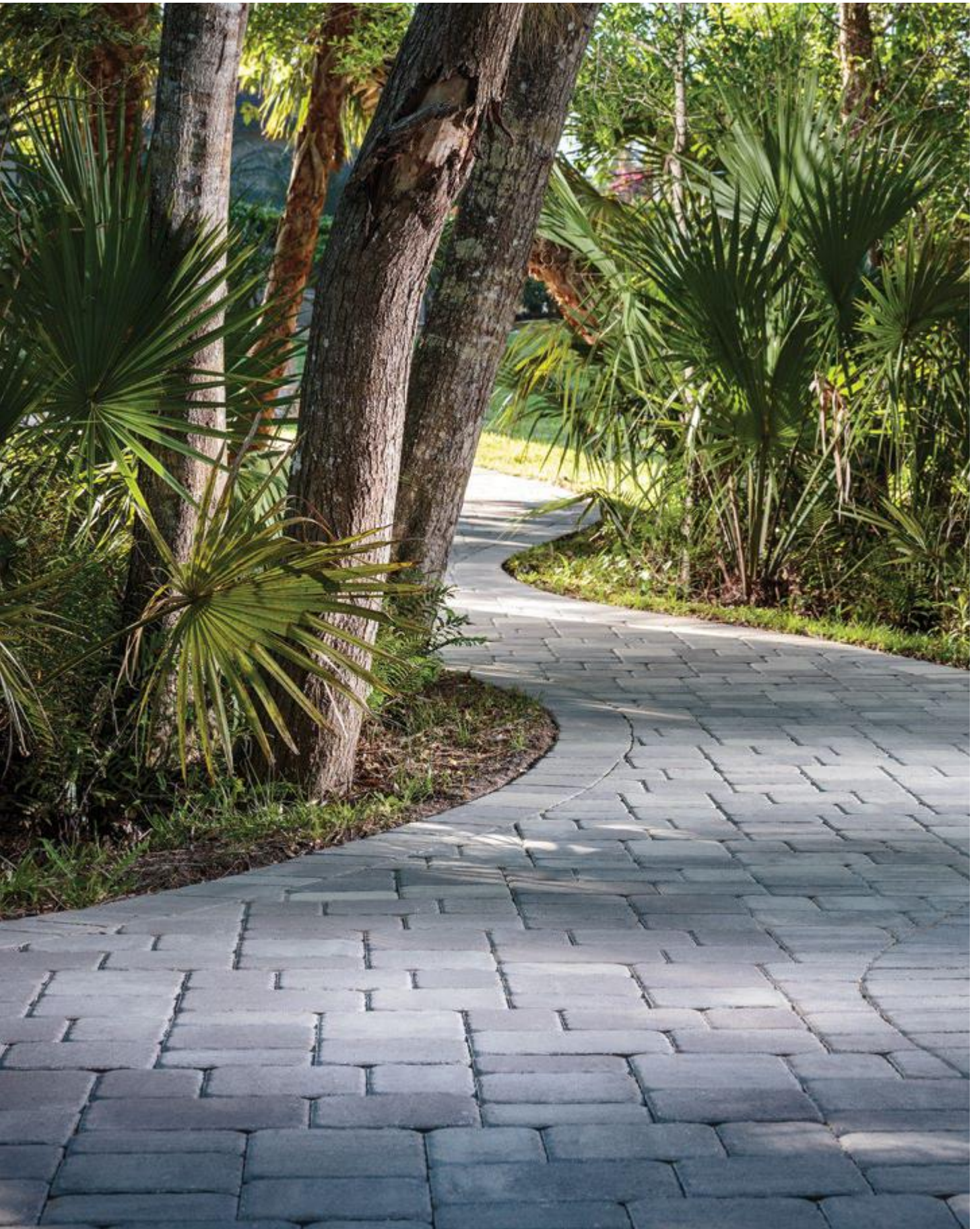

PEACE OF MIND, GUARANTEED

LIFETIME TRANSFERABLE LIMITED WARRANTY

Oldcastle® APG, Inc. ("Belgard") is proud to inform you that all of our interlocking concrete paver and retaining walls ("Products") meet and/or exceed the requirements of ASTM C-936 and ASTM C-1372. Belgard® guarantees its Products against these standards for the lifetime of the Product defined by ICPI. This guarantee does not apply to splitting, chipping or other breakage that could be caused by impact, abrasion or overloading. This warranty is transferable. The original proof of purchase is required.

This warranty is only valid if the material is installed under the guidelines of the ICPI (www.ICPI.org), The NCMA (www.ncma.org) or the Belgard Installation Guideline Manual. Improper installation voids this warranty. This warranty is for residential applications only and does not apply to commercial applications. It is recommended that the job be installed by a Belgard Contractor who provides a guaranty of their workmanship for a minimum of 3 years from the date of install. For warranty service, contact Belgard at 1-877-BELGARD. A service representative will investigate your claim within 10 business days. If the Belgard product fails to meet the specifications, Belgard will replace the defective product at no charge. Color matching cannot be guaranteed. Belgard will not be responsible for any replacement labor, consequential damages or incidental damages. This warranty gives you specific legal rights, and you may also have other rights which vary from state to state. Some states do not allow for the exclusion or limitation of incidental or consequential damages, so the above limitation or exclusion may not apply to you. All other warranties, express or implied are waived.

For specific information regarding warranty coverage and exclusions in regards to the Elements and Porcelain Paver products, please visit: Belgard.com/Warranty

STAY CONNECTED



OutdoorLivingbyBelgard



Belgard



BelgardHardscapes



Belgard



BelgardOutdoorLiving



Belgard.com/Blog

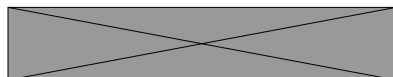

COASTAL LOCATIONS

5959 Soutel Drive
Jacksonville, FL 32219
Ph: 904-713-9996
Fx: 904-713-9985

7167 Interpace
West Palm Beach, FL 33407
Ph: 800-226-0004
Fx: 561-844-5454

2902 Warehouse Road
Ft. Myers, FL 33916
Ph: 239-334-8022
Fx: 239-334-0870

421 Leonard Blvd North
Lehigh Acres, FL 33971
Ph: 239-368-9700
Fx: 239-368-3924

39 West Landstreet Road
Orlando, FL 32824
Ph: 800-226-9117
Fx: 407-851-9316

3302 NE 2nd Street
Gainesville, FL 32609
Ph: 352-377-1699
Fx: 352-377-2604

3749 Copeland Drive
Zephyrhills, FL 33542
Ph: 888-321-2354
Fx: 813-783-2728

28 Gene Hurley Road
De Funiak Springs, FL
32435
Ph: 850-892-5155
Fx: 850-892-7247

2200 12th Street
Sarasota, FL 34237
Ph: 941-957-3933
Fx: 941-366-1343

325 North Street
Longwood, FL 32750
Ph: 407-831-1050
Fx: 407-331-6150

1590 N. Andrews Ave. Ext.
Pompano Beach, FL 33069
Ph: 954-972-7400
Fx: 855-265-5169

SHOWROOMS

8910 North 12th Street
Tampa, FL 33604
Ph: 800-356-7283
Fx: 813-933-4914

5603 Anderson Road
Tampa, FL 33614
Ph: 813-886-7761
Fx: 813-886-8822

1980 Marley Drive
Haines City, FL 33844
Ph: 863-421-7422
Fx: 863-421-1250

6187 Shirley Street
Naples, FL 34109
Ph: 239-633-2596
By appointment only
2874 NW 79 Ave.
Doral, FL 33122
Ph: 305-216-0947
By appointment only

